



# Dell V515w User's Guide

**April 2009**

**[www.dell.com](http://www.dell.com) | [support.dell.com](http://support.dell.com)**

---

Machine type(s):

4443

Model(s):

2dw, 6dw

**Trademarks**

Information in this document is subject to change without notice.

Reproduction in any manner whatsoever without the written permission of Dell Inc. is strictly forbidden. Trademarks used in this text: *Dell* and the *DELL* logo are trademarks of Dell Inc.; *Microsoft* and *Windows* are registered trademarks of Microsoft Corporation. Other trademarks and trade names may be used in this document to refer to the entities claiming the marks and names of their products. Dell Inc. disclaims any proprietary interest in trademarks and trade names other than its own.

# Contents

<b>Safety information.....</b>	<b>7</b>
<b>About your printer.....</b>	<b>8</b>
Thank you for choosing this printer!.....	8
Minimizing your printer's environmental impact.....	8
Finding information about the printer.....	9
Understanding the parts of the printer.....	11
<b>Ordering and replacing supplies.....</b>	<b>13</b>
Replacing ink cartridges.....	13
Ordering ink cartridges.....	14
Recycling Dell products.....	15
<b>Using the printer control panel buttons and menus.....</b>	<b>16</b>
Using the printer control panel.....	16
Using the printer menus.....	18
Changing temporary settings into new default settings.....	20
Changing the Power Saver timeout.....	21
Resetting to factory settings.....	21
Saving energy with Eco-Mode.....	22
<b>Using the printer software.....</b>	<b>23</b>
Minimum system requirements.....	23
Using the Windows printer software.....	23
Updating the printer software (Windows only).....	25
Reinstalling the printer software.....	25
<b>Loading paper and original documents.....</b>	<b>26</b>
Loading paper.....	26
Saving paper default settings.....	28
Loading original documents on the scanner glass.....	29
Loading original documents into the ADF.....	29
<b>Printing.....</b>	<b>31</b>
Tips for printing.....	31

Printing basic documents.....	31
Printing specialty documents.....	33
Printing on both sides of the paper (duplexing) manually.....	34
Working with photos.....	36
Printing from a Bluetooth-enabled device.....	41
Managing print jobs.....	44
<b>Copying.....</b>	<b>47</b>
Tips for copying.....	47
Making copies.....	47
Copying photos.....	47
Enlarging or reducing images.....	48
Adjusting copy quality.....	48
Making a copy lighter or darker.....	49
Collating copies using the printer control panel.....	49
Repeating an image on one page.....	50
Copying multiple pages on one sheet.....	50
Making a duplex copy manually.....	50
Canceling copy jobs.....	51
<b>Scanning.....</b>	<b>52</b>
Tips for scanning.....	52
Scanning to a local or network computer.....	52
Scanning to a flash drive or memory card.....	53
Scanning photos into an editing application.....	53
Scanning documents into an editing application.....	54
Scanning directly to e-mail.....	54
Scanning to a PDF.....	55
Scanning FAQ.....	55
Canceling scan jobs.....	56
<b>Faxing.....</b>	<b>57</b>
Setting up the printer to fax.....	57
Configuring the fax settings.....	68
Creating a contact list.....	70
Sending faxes.....	71
Receiving faxes.....	72

Faxing FAQ.....	73
<b>Networking.....</b>	<b>80</b>
Installing the printer on a wireless network.....	80
Advanced wireless setup.....	84
Networking FAQ.....	88
<b>Maintaining the printer.....</b>	<b>98</b>
Maintaining ink cartridges.....	98
Cleaning the exterior of the printer.....	99
Cleaning the scanner glass.....	100
<b>Troubleshooting.....</b>	<b>101</b>
Before you troubleshoot.....	101
Using the Service Center to solve printer problems.....	101
If Troubleshooting does not solve your problem.....	101
Setup troubleshooting.....	101
Jams and misfeeds troubleshooting.....	106
Print troubleshooting.....	108
Copy and scan troubleshooting.....	110
Fax troubleshooting.....	112
Memory card troubleshooting.....	118
Wireless troubleshooting.....	119
<b>Index.....</b>	<b>135</b>



# Safety information

Connect the power cord to a properly grounded electrical outlet that is near the product and easily accessible.

Do not place or use this product near water or wet locations.

Use only the power supply and power cord provided with this product or the manufacturer's authorized replacements.

This product is designed, tested, and approved to meet strict global safety standards with the use of specific manufacturer's components. The safety features of some parts may not always be obvious. The manufacturer is not responsible for the use of other replacement parts.

 **CAUTION—POTENTIAL INJURY:** Do not cut, twist, bind, crush, or place heavy objects on the power cord. Do not subject the power cord to abrasion or stress. Do not pinch the power cord between objects such as furniture and walls. If any of these things happen, a risk of fire or electrical shock results. Inspect the power cord regularly for signs of such problems. Remove the power cord from the electrical outlet before inspecting it.

Refer service or repairs, other than those described in the user documentation, to a professional service person.

 **CAUTION—SHOCK HAZARD:** To avoid the risk of electric shock when cleaning the exterior of the printer, unplug the power cord from the wall outlet and disconnect all cables from the printer before proceeding.

 **CAUTION—SHOCK HAZARD:** Do not use the fax feature during a lightning storm. Do not set up this product or make any electrical or cabling connections, such as the fax feature, power cord, or telephone, during a lightning storm.

**SAVE THESE INSTRUCTIONS.**

# About your printer

## Thank you for choosing this printer!

We've worked hard to make sure it will meet your needs.

To start using your new printer right away, use the setup materials that came with the printer, and then skim the *User's Guide* to learn how to perform basic tasks. To get the most out of your printer, read the *User's Guide* carefully, and make sure you check the latest updates on our Web site.

We're committed to delivering performance and value with our printers, and we want to make sure you're satisfied. If you do encounter any problems along the way, one of our knowledgeable support representatives will be delighted to help you get back on track fast. And if you find something we could do better, please let us know. After all, you are the reason we do what we do, and your suggestions help us do it better.

## Minimizing your printer's environmental impact

We are committed to protecting the environment and are continually improving our printers to reduce their environmental impact. By selecting certain printer settings or tasks, you may be able to reduce your printer's environmental impact even further.

### Conserving energy

- **Eco-Mode.** This feature sets the screen brightness to low and sets the printer to change to Power Saver mode after the printer is left idle for 10 minutes. Eco-Mode is enabled by default in your printer.
- **Select the lowest Power Saver timeout.** The Power Saver feature puts the printer in a minimum-power standby mode after the printer has been idle for a set amount of time (the Power Saver timeout).
- **Share your printer.** Wireless/network printers allow you to share a single printer among multiple computers, thus conserving energy and other resources.

### Conserving paper

- **Print more than one page image on one side of the paper.** The "Pages per sheet" feature allows you to print multiple pages on one sheet. You can print up to 8 page images on one side of a sheet of paper.
- **Print on both sides of the paper.** Duplexing lets you print on both sides of the paper manually or automatically (depending on your printer model).
- **Preview print jobs before printing.** Use the preview features found in the Print Preview dialog or the printer display (depending on your printer model).
- **Scan and save.** To avoid printing multiple copies, you can scan documents or photographs and save them to a computer program, application, or flash drive for presentation.
- **Use recycled paper.**

### Conserving ink

- **Use Quick Print or Draft Mode.** These modes can be used to print documents using less ink than normal and are ideal for printing documents that are mostly text.
- **Use High Yield cartridges.** Inks in High-Yield cartridges allow you to print more pages with fewer cartridges.



- **Clean the printhead.** Before replacing and recycling your ink cartridges, try using the “Clean Printhead” and “Deep Clean Printhead” features. These features clean the printhead nozzles to improve the quality of your prints.

## Recycling

- **Return empty ink cartridges for reuse or recycling through the Dell Cartridge Collection Program.** To return an empty ink cartridge, go to [www.dell.com/recycling](http://www.dell.com/recycling) to request a postage-paid bag.
- **Recycle the product packaging.**
- **Recycle your old printer instead of throwing it away.**
- **Recycle paper from discarded print jobs.**
- **Use recycled paper.**

## Finding information about the printer

### Publications

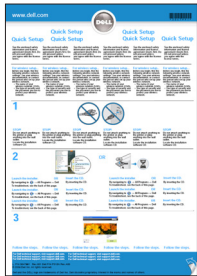
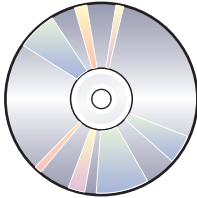
What are you looking for?	Find it here
<p>Initial setup instructions:</p> <ul style="list-style-type: none"> <li>• Connecting the printer</li> <li>• Installing the printer software</li> </ul>	<p>Setup documentation The setup documentation came with the printer.</p> 
<p>Additional setup and instructions for using the printer:</p> <ul style="list-style-type: none"> <li>• Selecting and storing paper and specialty media</li> <li>• Loading paper</li> <li>• Performing printing, copying, scanning, and faxing tasks, depending on your printer model</li> <li>• Configuring printer settings</li> <li>• Viewing and printing documents and photos</li> <li>• Setting up and using printer software</li> <li>• Setting up and configuring the printer on a network, depending on your printer model</li> <li>• Caring for and maintaining the printer</li> <li>• Troubleshooting and solving problems</li> </ul>	<p><i>User's Guide</i> The <i>User's Guide</i> is available on the installation software CD.</p>  <p>For updates, check our Web site at <a href="http://support.dell.com">support.dell.com</a>.</p>

What are you looking for?	Find it here
<p>Help using the printer software</p>	<p>Windows Help</p> <p>Open a printer software program or application, and then click <b>Help</b>.</p> <p>Click  to view context-sensitive information.</p> <p><b>Notes:</b></p> <ul style="list-style-type: none"> <li>• The Help installs automatically with the printer software.</li> <li>• The printer software is located in the printer Program folder or on the desktop, depending on your operating system.</li> </ul>
<p>The latest supplemental information, updates, and online technical support:</p> <ul style="list-style-type: none"> <li>• Troubleshooting hints and tips</li> <li>• Frequently asked questions</li> <li>• Documentation</li> <li>• Driver downloads</li> <li>• Live chat support</li> <li>• E-mail support</li> <li>• Telephone support</li> </ul>	<p>Dell Support Web site—<b>support.dell.com</b></p> <p><b>Note:</b> Select your region, and then select your product to view the appropriate support site.</p> <p>Support telephone numbers and hours of operation for your region or country can be found on the Support Web site.</p> <p>Have the following information ready when you contact support so that they may serve you faster:</p> <ul style="list-style-type: none"> <li>• Service Tag</li> <li>• Express Service Code</li> </ul> <p><b>Note:</b> The Service Tag and Express Service Code appear on labels located on your printer.</p>
<ul style="list-style-type: none"> <li>• Software and Drivers—Certified drivers for your printer and installers for Dell printer software</li> <li>• Readme files—Last-minute technical changes, or advanced technical reference material for experienced users or technicians</li> </ul>	<p>Installation software CD</p> <p><b>Note:</b> If you purchased your Dell computer and printer at the same time, then documentation and drivers for your printer are already installed on your computer.</p>
<ul style="list-style-type: none"> <li>• Supplies and accessories for your printer</li> <li>• Replacement cartridges</li> </ul>	<p>Dell Printer Supplies Web site—<b>dell.com/supplies</b></p> <p>You can purchase printer supplies online, by telephone, or in select retail stores.</p>
<ul style="list-style-type: none"> <li>• Safety information for preparing to operate your printer</li> <li>• Regulatory information</li> <li>• Warranty information</li> </ul>	<p><i>Product Information Guide</i></p> <div data-bbox="1068 1430 1263 1675" style="border: 1px solid black; padding: 5px; text-align: center;"> <p><small>PLEASE READ THIS DOCUMENT CAREFULLY. IT CONTAINS THE TERMS AND CONDITIONS OF SALE THAT GOVERN YOUR PURCHASE. PRINTING THIS GUIDE IS SUBJECT TO THESE TERMS AND CONDITIONS. THESE TERMS AND CONDITIONS APPLY TO ALL PURCHASES OF THIS PRODUCT, WHETHER PURCHASED ONLINE, BY TELEPHONE, OR IN SELECT RETAIL STORES. ALL DELLS ARE SUBJECT TO THESE TERMS AND CONDITIONS. FOR MORE INFORMATION, VISIT <a href="http://www.dell.com/termsandconditions">www.dell.com/termsandconditions</a>.</small></p> <p><b>Dell™ Printers</b></p> <p><b>Product Information Guide</b></p> <p><small>© 2010 Dell Inc. All rights reserved. Dell, the Dell logo, and Dell Inspiron are trademarks or registered trademarks of Dell Inc. in the United States and other countries. Other brands and product names are trademarks of their respective owners.</small></p> </div> <p><b>Note:</b> The <i>Product Information Guide</i> may not be available in your country or region.</p>

# Understanding the parts of the printer

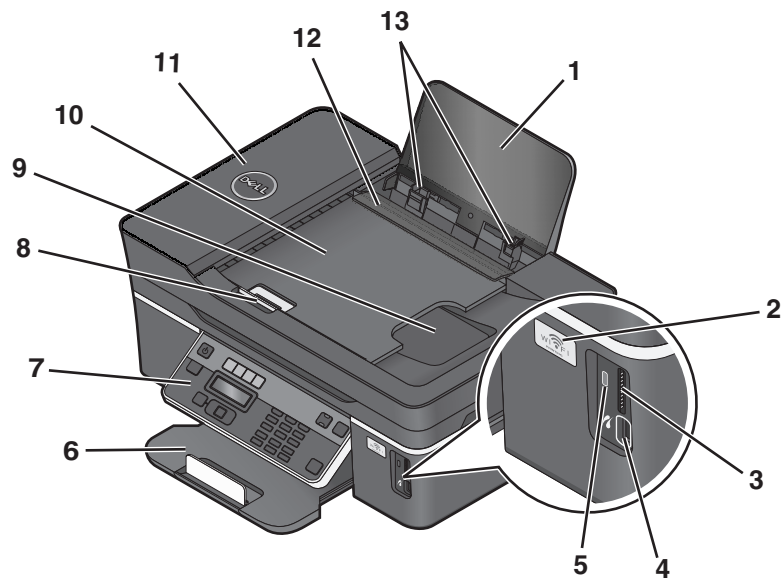

	Use the	To
1	Paper support	Load paper.
2	Wi-Fi indicator	Check wireless status.
3	Memory card slots	Insert a memory card.
4	PictBridge and USB port	Connect a PictBridge-enabled digital camera, USB Bluetooth adapter, or a flash drive to the printer.
5	Card reader light	Check card reader status. The light blinks to indicate that a memory card is being accessed.
6	Paper exit tray	Hold paper as it exits.
7	Printer control panel	Operate the printer.
8	Automatic Document Feeder (ADF) paper guide	Keep paper straight when feeding it into the ADF. <b>Note:</b> Adjust the paper guide on the ADF tray to the width of the original document.
9	ADF output tray	Hold documents as they exit from the ADF.
10	ADF tray	Load original documents in the ADF. Recommended for scanning, copying, or faxing multiple-page documents. <b>Note:</b> Do not load postcards, photos, small items, or thin media (such as magazine clippings) into the ADF. Place these items on the scanner glass.
11	ADF	Scan, copy, or fax multiple-page letter-, legal-, and A4-size documents.
12	Paper feed guard	Prevent items from falling into the paper slot.
13	Paper guides	Keep paper straight when feeding.

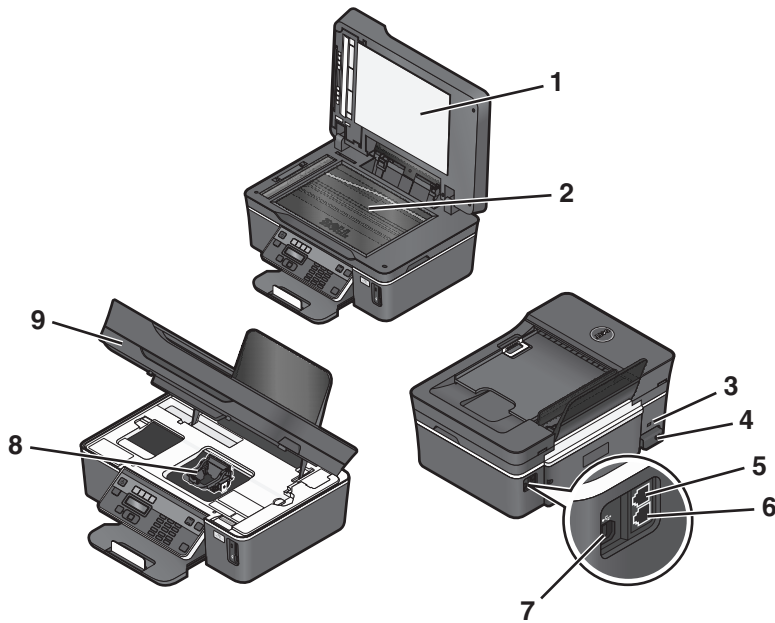

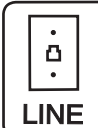
	Use the	To
1	Top cover	Access the scanner glass.
2	Scanner glass	Scan and copy photos and documents.
3	Security slot	Install an anti-theft cable on your printer.
4	Power supply with port	Connect the printer to a power source.
5	EXT Port 	Connect additional devices (telephone or answering machine) to the printer and the telephone line. Use this port if you do not have a dedicated fax line for the printer, and if this connection method is supported in your country or region. <b>Note:</b> Remove the plug to access the port.
6	LINE Port 	Connect the printer to an active telephone line (through a standard wall jack, DSL filter, or VoIP adapter) to send and receive faxes.
7	USB port	Connect the printer to a computer using a USB cable. <b>Warning—Potential Damage:</b> Do not touch the USB port except when plugging in or removing a USB cable or installation cable.
8	Printhead	Install, replace, or remove ink cartridges.
9	Scanner unit	<ul style="list-style-type: none"> <li>• Access the ink cartridges and printhead.</li> <li>• Remove paper jams.</li> </ul>

# Ordering and replacing supplies

## Replacing ink cartridges

Make sure you have a new ink cartridge or cartridges before you begin. You must install new cartridges immediately after removing the old ones, or the ink remaining in the printhead nozzles may dry out.

- 1 Turn on your printer.
- 2 Open the printer.

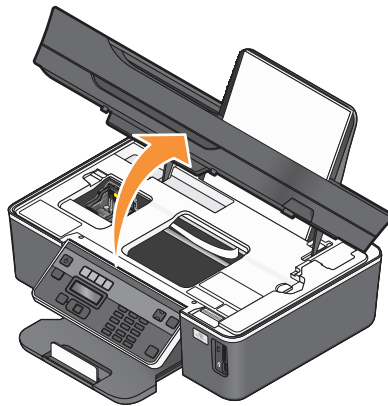

**Note:** The printhead moves to the cartridge installation position.

- 3 Press the release tab, and then remove the used ink cartridge or cartridges.

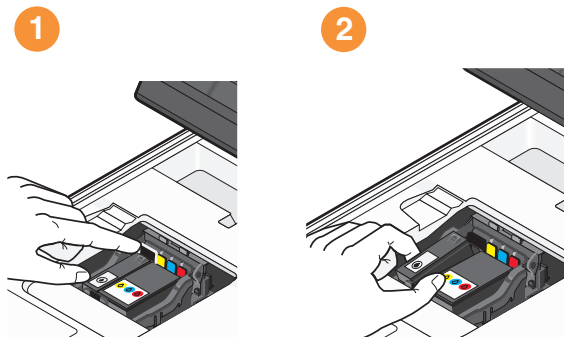

**Note:** Do not reinstall used ink cartridges once you remove them from the printhead.

- 4 Remove the new cartridges from the foil, and then remove the protective cap from each of the ink cartridges. Install the black ink cartridge and then the color ink cartridge. Use two hands to install each cartridge.

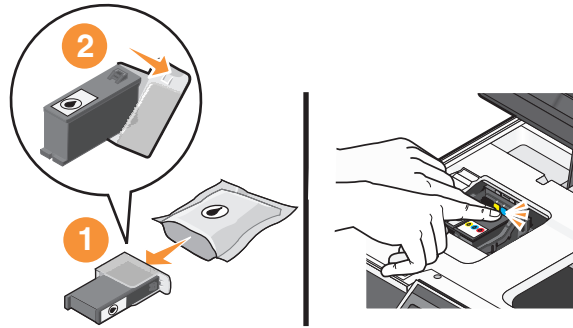

**Note:** Install the ink cartridges immediately after removing the protective cap to avoid exposing the ink to air.

- 5 Close the printer.

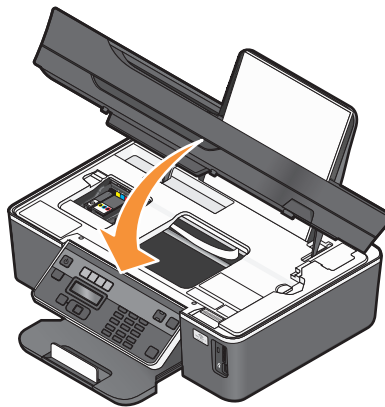

## Ordering ink cartridges

Page yields available at [www.dell.com/supplies](http://www.dell.com/supplies). For best results, use only Dell ink cartridges.



Item	Licensed cartridge <sup>1</sup>	Regular cartridge
Black cartridge	Series 21	Series 21R
Black cartridge, high yield <sup>2</sup>	Series 23	Series 23R
Color cartridge	Series 21	Series 21R
Color cartridge, high yield <sup>2</sup>	Series 23	Series 23R

<sup>1</sup> Licensed for a single use only. After use, return this cartridge to Dell for remanufacturing, refilling, or recycling. To know more about recycling Dell products, visit [www.dell.com/recycling](http://www.dell.com/recycling).

<sup>2</sup> Available only on the Dell Web site at [www.dell.com/supplies](http://www.dell.com/supplies).

# Recycling Dell products

To return Dell products to Dell for recycling:





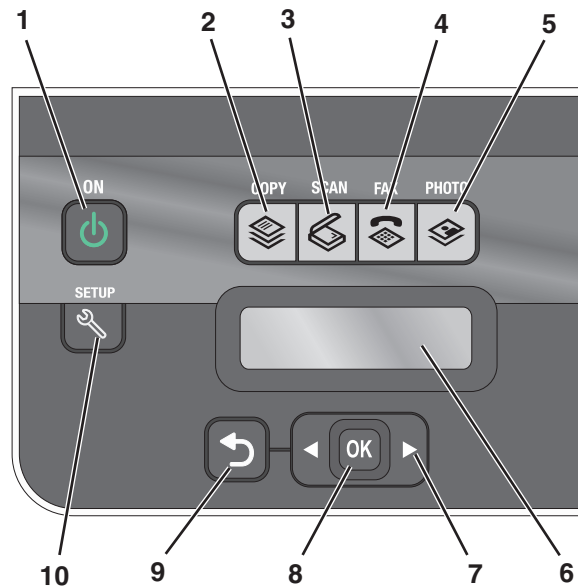

- 1 Click  or **Start**.
- 2 Click **All Programs** or **Programs**, and then select the printer program folder from the list.
- 3 Select **Printer Home**.
- 4 Choose your printer from the printer drop-down list.
- 5 Click **Order supplies** in the Maintenance tab.
- 6 Click .
- 7 Follow the instructions on the computer screen.

# Using the printer control panel buttons and menus



## Using the printer control panel

The following diagrams explain the sections of the printer control panel:



	Use the:	To
1	Power button 	<ul style="list-style-type: none"> <li>Turn the printer on and off.</li> <li>Switch to Power Saver mode.</li> </ul> <p><b>Note:</b> When the printer is on, press  to switch to Power Saver mode. Press and hold  for three seconds to turn off the printer.</p>
2	Copy button 	Access the copy menu and make copies.
3	Scan button 	Access the scan menu and scan documents.
4	Fax button 	Access the fax menu and send faxes.
5	Photo button 	Access the photo menu and print photos.



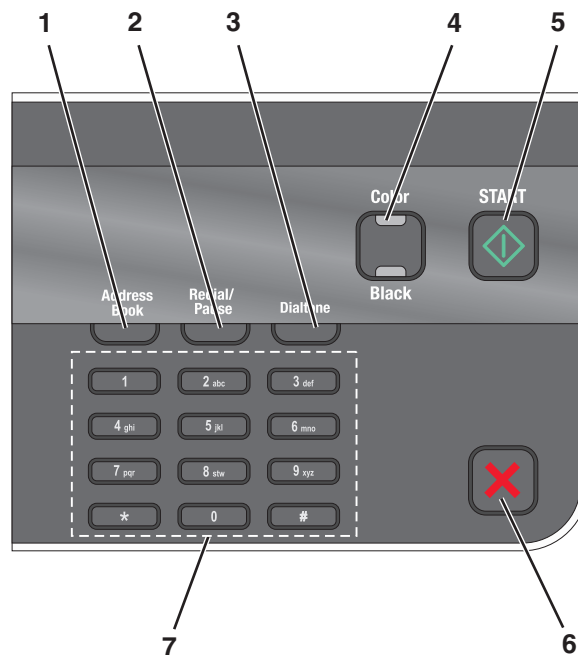

	Use the:	To
6	Display <b>Note:</b> The display is turned off in Power Saver mode.	View: <ul style="list-style-type: none"> <li>• Printer status</li> <li>• Messages</li> <li>• Menus</li> </ul>
7	Arrow buttons	Choose a menu or submenu item that appears on the display.
8	Select button 	<ul style="list-style-type: none"> <li>• Select menu options.</li> <li>• Save settings.</li> <li>• Feed or eject paper. Press and hold for 3 seconds to feed or eject paper from the printer.</li> </ul>
9	Back button 	<ul style="list-style-type: none"> <li>• Return to the previous screen.</li> <li>• Exit from one menu level to a higher one.</li> </ul>
10	Setup button 	Access the setup menu and change printer settings. <b>Note:</b> The Copy, Scan, Fax, and Photo button lights are off when this button is selected.



	Use the:	To
1	<b>Address Book</b>	Access fax numbers from a saved list of numbers.
2	<b>Redial/Pause</b>	In Fax mode: <ul style="list-style-type: none"> <li>• Insert a three-second pause in a fax number to wait for an outside line or get through an automated answering system. Enter a pause only when you have already begun entering the number.</li> <li>• Display the last number dialed. Press the left or right arrow button to view the last five numbers dialed.</li> </ul>

Using the printer control panel buttons and menus

	Use the:	To
3	<b>Dialtone</b>	Dial the telephone number manually using the keypad before sending the fax.
4	<b>Color/Black</b>	Switch to color mode or black-and-white mode.
5	Start button 	Start a print, scan, fax, or copy job, depending on which mode is selected.
6	Cancel button 	<ul style="list-style-type: none"> <li>• Cancel a print, copy, scan, or fax job in progress.</li> <li>• Exit from a menu level of the Copy, Scan, Fax, Photo, or File Print menu to the top level of a menu.</li> <li>• Exit from a menu level of the Setup menu to the top level of the previous mode.</li> <li>• Clear current settings or error messages, and return to default settings.</li> </ul>
7	<b>Keypad</b>	<p>In Copy mode or Photo mode: enter the number of copies or prints you want to make.</p> <p>In Fax mode:</p> <ul style="list-style-type: none"> <li>• Enter fax numbers.</li> <li>• Navigate an automated answering system.</li> <li>• Select letters when creating a Speed Dial list.</li> <li>• Type numbers to enter or edit the date and time shown on the display.</li> </ul>

## Using the printer menus

Copy menu	Scan menu	Fax menu	PictBridge menu <sup>1</sup>
Copies Quality Lighter/Darker Resize Original Size Photo Reprint Collate Pages per Sheet Copies per Sheet Content Type ID Card Copy	Scan to <ul style="list-style-type: none"> <li>• Computer               <ul style="list-style-type: none"> <li>– Application</li> <li>– Quality</li> <li>– Original Size</li> </ul> </li> <li>• Network               <ul style="list-style-type: none"> <li>– Quality</li> <li>– File Type</li> <li>– Original Size</li> </ul> </li> <li>• USB Flash Drive               <ul style="list-style-type: none"> <li>– Quality</li> <li>– File Type</li> <li>– Original Size</li> </ul> </li> <li>• Memory Card               <ul style="list-style-type: none"> <li>– Quality</li> <li>– File Type</li> <li>– Original Size</li> </ul> </li> </ul>	Fax to Quality <ul style="list-style-type: none"> <li>• Standard</li> <li>• Fine</li> <li>• Superfine</li> <li>• Ultrafine</li> </ul> Lighter/Darker Original Size <ul style="list-style-type: none"> <li>• Letter</li> <li>• A4</li> <li>• Legal</li> </ul> Schedule Fax <ul style="list-style-type: none"> <li>• Send Now</li> <li>• Send Later</li> <li>• View Pending</li> </ul>	Paper Size Photo Size Paper Type Layout Quality

<sup>1</sup> This menu appears only when a PictBridge-enabled camera is inserted into the PictBridge port.

Photo menu			
<b>Easy Photo</b> <ul style="list-style-type: none"> <li>• Print <ul style="list-style-type: none"> <li>– Last Photo</li> <li>– All Photos</li> <li>– Date Range</li> <li>– Photo Number</li> </ul> </li> <li>• Paper Size</li> <li>• Photo Size</li> </ul>	<b>Print Photos</b> <ul style="list-style-type: none"> <li>• Print <ul style="list-style-type: none"> <li>– Last Photo</li> <li>– All Photos</li> <li>– Date Range</li> <li>– Photo Number</li> <li>– Print DPOF<sup>1</sup></li> </ul> </li> <li>• Lighter/Darker</li> </ul>	<ul style="list-style-type: none"> <li>• Photo Effects <ul style="list-style-type: none"> <li>– None</li> <li>– Auto Enhance</li> <li>– Sepia</li> <li>– Antique Grey</li> <li>– Antique Brown</li> </ul> </li> <li>• Paper Size</li> <li>• Photo Size</li> <li>• Paper Type</li> <li>• Layout</li> <li>• Quality</li> </ul>	<b>Proof Sheet</b> <ul style="list-style-type: none"> <li>• Print Last 20</li> <li>• Print All</li> <li>• Print Date Range</li> <li>• Scan Sheet</li> </ul> <b>Save Photos</b> <ul style="list-style-type: none"> <li>• Computer<sup>2</sup></li> <li>• Network</li> <li>• USB Flash Drive<sup>3</sup></li> <li>• Memory Card<sup>3</sup></li> </ul> Select Computer (appears only in printers connected to a network)

<sup>1</sup> This menu appears only when there is a valid DPOF file in your memory device.

<sup>2</sup> This menu appears only when the printer is connected to the computer through the USB port.

<sup>3</sup> This menu appears only when a memory device is inserted into the card slot or USB port.

Setup menu			
<b>Paper Setup</b> <ul style="list-style-type: none"> <li>• Paper Size</li> <li>• Paper Type</li> </ul> <b>Maintenance</b> <ul style="list-style-type: none"> <li>• Ink Levels</li> <li>• Clean Printhead</li> <li>• Deep Clean Printhead</li> <li>• Align Printer</li> <li>• Print Test Page</li> <li>• Replace Printhead</li> </ul>	<b>Device Setup</b> <ul style="list-style-type: none"> <li>• Language</li> <li>• Country/Region</li> <li>• Date/Time</li> <li>• Host Fax Settings</li> <li>• Button Beep</li> <li>• Power Saver</li> <li>• Auto Screen Dim</li> <li>• Eco-Mode</li> <li>• Clear Settings Timeout</li> </ul>	<b>Network Setup<sup>1</sup></b> <ul style="list-style-type: none"> <li>• Print Setup Page</li> <li>• Wi-Fi Protected Setup</li> <li>• Wireless Information</li> <li>• TCP/IP</li> <li>• File Print</li> <li>• Reset Network Adapter Defaults</li> </ul> <b>Fax Setup</b> <ul style="list-style-type: none"> <li>• Address Book</li> <li>• Reports</li> <li>• Ringing and Answering</li> <li>• Fax Printing</li> <li>• Dialing and Sending</li> <li>• Fax Blocking</li> </ul>	<b>Bluetooth Setup<sup>2</sup></b> <ul style="list-style-type: none"> <li>• Enable</li> <li>• Discovery</li> <li>• Printer Name</li> <li>• Security Level</li> <li>• Paper Size</li> <li>• Photo Size</li> <li>• Paper Type</li> <li>• Quality</li> <li>• Pass Key</li> <li>• Clear Device List</li> </ul> <b>Defaults</b> <ul style="list-style-type: none"> <li>• Photo Print Size</li> <li>• Set Defaults <ul style="list-style-type: none"> <li>– Use Current</li> <li>– Use Factory</li> </ul> </li> </ul> <b>Demo Mode</b> <ul style="list-style-type: none"> <li>• On</li> <li>• Off</li> </ul>

<sup>1</sup> This menu appears only in printers that support wireless printing.

<sup>2</sup> This menu appears only when a USB Bluetooth adapter is inserted into the USB port.



**Note:** The File Print menu is enabled when you insert a memory device that contains document files into the printer. The menu is composed of the folders and files stored on the memory device.

# Changing temporary settings into new default settings

The following menus revert to default settings after two minutes of inactivity or after the printer is turned off:

Copy menu	<ul style="list-style-type: none"><li>• Copies</li><li>• Quality</li><li>• Lighter/Darker</li><li>• Resize</li><li>• Original Size</li><li>• Pages per Sheet</li><li>• Copies per Sheet</li><li>• Content Type</li></ul>
Scan menu	<ul style="list-style-type: none"><li>• Quality</li><li>• Original Size</li></ul>
Fax menu (selected models only)	<ul style="list-style-type: none"><li>• Lighter/Darker</li><li>• Quality</li></ul>
Photo menu	<p>The following Photo options will not time out after two minutes of inactivity or after you turn off the printer, but they will return to the factory default settings when a memory card or flash drive is removed.</p> <ul style="list-style-type: none"><li>• Photo Effects</li><li>• Photo Size</li><li>• Layout</li><li>• Quality</li></ul>

## To change the temporary settings into new default settings

- 1 From the printer control panel, press .
- 2 Press the arrow buttons to scroll to **Defaults**, and then press **OK**.
- 3 Press the arrow buttons to scroll to **Set Defaults**, and then press **OK**.  
**Use Current** appears on the display.
- 4 Press **OK** again to select **Use Current**.
- 5 Press  until you exit Setup, or press another mode button.

## To disable the settings timeout feature



You can disable the settings timeout feature if you do not want the printer to revert to the default settings after two minutes of inactivity or after the printer is turned off.

- 1 From the printer control panel, press .
- 2 Press the arrow buttons to scroll to **Device Setup**, and then press **OK**.
- 3 Press the arrow buttons to scroll to **Clear Settings Timeout**, and then press **OK**.

- 4 Press the arrow buttons to scroll to **Never**, and then press **OK**.
- 5 Press  until you exit Setup, or press another mode button.

## Changing the Power Saver timeout

The Power Saver timeout is the time it takes for the printer to switch to Power Saver mode when the printer is left idle. The Power Saver feature optimizes energy efficiency by reducing the printer power consumption (as much as 28 percent on some printer models) compared to the default printer settings. To save the most energy, select the lowest Power Saver timeout.

- 1 From the printer control panel, press .
- 2 Press the arrow buttons to scroll to **Device Setup**, and then press **OK**.
- 3 Press the arrow buttons to scroll to **Power Saver**, and then press **OK**.
- 4 Press the arrow buttons to select a Power Saver timeout, and then press **OK**.
- 5 Press  until you exit Setup, or press another mode button.





## Resetting to factory settings

Resetting to factory default settings will delete all the printer settings you have previously selected.

### Using the printer control panel menus

- 1 From the printer control panel, press .
- 2 Press the arrow buttons to scroll to **Defaults**, and then press **OK**.
- 3 Press the arrow buttons to scroll to **Set Defaults**, and then press **OK**.
- 4 Press the arrow buttons to scroll to **Use Factory**, and then press **OK**.
- 5 When prompted to set the initial settings of your printer, make your selections using the printer control panel buttons.  
**Initial Setup Complete** appears on the display.

### Using a button combination (if you cannot read the current language)

- 1 Turn off the printer.  
**Note:** If you have set the Power Saver timeout in the Setup menu, then press and hold the  for three seconds to turn off the printer.
- 2 From the printer control panel, press and hold  and , and then press  to turn the printer on.
- 3 Release all three buttons.
- 4 When prompted to set the initial settings of your printer, make your selections using the printer control panel buttons.  
**Initial Setup Complete** appears on the display.

# Saving energy with Eco-Mode

The Eco-Mode feature optimizes energy efficiency and saves money.



When Eco-Mode is enabled, the printer automatically switches to the following settings:

- The printer display is dimmed.
- The printer changes to Power Saver mode after ten minutes.

## Notes:

- If you are using Eco-Mode, then the Eco-Mode settings override any changes you may make to individual settings that are part of Eco-Mode.
- Eco-Mode is enabled by default.

To change the Eco-Mode setting:

- 1 From the printer control panel, press .
- 2 Press the arrow buttons to scroll to **Device Setup**, and then press **OK**.
- 3 Press the arrow buttons to scroll to **Eco-Mode**.
- 4 Select the Eco-Mode setting, and then press **OK**.
- 5 Press  until you exit Setup, or press another mode button.

# Using the printer software

## Minimum system requirements

The printer software requires up to 500 MB of free disk space.

## Supported operating systems

- Microsoft Windows 7 (Web only)
- Microsoft Windows Vista
- Microsoft Windows XP
- Microsoft Windows 2000 (SP4 or greater)
- Linux Ubuntu 8.04 LTS and 8.10 (Web only)
- Linux OpenSUSE 11.0 and 11.1 (Web only)
- Linux Fedora 10 (Web only)

## Using the Windows printer software

### Software installed during printer installation

When you set up the printer using the installation software CD, all the necessary software was installed. You may have chosen to install some additional programs. The following table provides an overview of various software programs and what they can help you do.

If you did not install these additional programs during initial installation, then reinsert the installation software CD, run the installation software, and then select **Install Additional Software** from the Software Already Installed screen.

### Printer software

Use the	To
Dell Printer Home (referred to as Printer Home)	<ul style="list-style-type: none"><li>• Launch applications or programs.</li><li>• Access the Fax Solutions software.</li><li>• Scan or e-mail a photo or document.</li><li>• Edit scanned documents.</li><li>• Scan documents to PDF.</li><li>• Adjust settings for the printer.</li><li>• Order supplies.</li><li>• Maintain ink cartridges.</li><li>• Print a test page.</li><li>• Register the printer.</li><li>• Contact technical support.</li></ul>
Dell Fast Pics (referred to as Fast Pics)	Manage, edit, transfer, and print photos and documents.

Use the	To
Adobe™ Photo Album Starter Edition	View, manage, and edit photos.
Dell Toolbar (referred to as Toolbar)	Print, scan, or convert local files from Windows.
Dell Ink Management System	Order ink.
Dell Fax Solutions (referred to as Fax Solutions)	<ul style="list-style-type: none"> <li>• Send a fax.</li> <li>• Receive a fax in three-in-one printers.</li> <li>• Add, edit, or delete contacts in the built-in phone book.</li> <li>• Access the Dell Fax Setup Utility. Use the Fax Setup Utility to set the Speed Dial and Group Dial numbers, set Ringing and Answering, and print fax history and status reports.</li> </ul>
Abbyy Sprint OCR	Scan a document and produce text that you can edit with a word-processing program.
Dell Wireless Setup Utility (referred to as Wireless Setup Utility)	<ul style="list-style-type: none"> <li>• Set up the wireless printer on a wireless network.</li> <li>• Change the wireless settings of the printer.</li> </ul> <p><b>Note:</b> This program is installed automatically with the printer software if the printer has wireless capability.</p>
Dell Service Center (referred to as Service Center)	<ul style="list-style-type: none"> <li>• Troubleshoot the printer.</li> <li>• Access the printer maintenance functions.</li> <li>• Contact technical support.</li> </ul> <p><b>Notes:</b></p> <ul style="list-style-type: none"> <li>• This program is installed automatically with the printer software.</li> <li>• You may be prompted to install this program from the Web, depending on your printer model.</li> </ul>
Printing Preferences	<p>When you select <b>File → Print</b> with a document open and then click <b>Properties</b>, a Printing Preferences dialog appears. The dialog lets you select options for the print job, such as the following:</p> <ul style="list-style-type: none"> <li>• Select the number of copies to print.</li> <li>• Print two-sided copies.</li> <li>• Select the paper type.</li> <li>• Add a watermark.</li> <li>• Enhance images.</li> <li>• Save settings.</li> </ul> <p><b>Note:</b> Printing Preferences is installed automatically with the printer software.</p>

**Note:** Your printer may not come with some of these programs or some of the functions of these programs, depending on the features of the printer that you purchased.



# Updating the printer software (Windows only)

## Checking for software updates

- 1 Click  or **Start**.
- 2 Click **All Programs** or **Programs**, and then select the printer program folder from the list.
- 3 Select **Printer Home**.
- 4 Choose your printer from the printer drop-down list.
- 5 From the Support tab, select **Check for updates**.
- 6 Follow the instructions on the computer screen.

## Reinstalling the printer software

If you encountered problems while installing, or if your printer does not appear in the Printers folder or as a printer option when you send a print job, then try removing and reinstalling the printer software.

## Uninstalling the printer software

- 1 Click  or **Start**.
- 2 Click **All Programs** or **Programs**, and then select the printer program folder from the list.
- 3 Select the uninstall option.
- 4 Follow the instructions on the computer screen to remove the software.
- 5 Once the uninstall process is complete, restart your computer.

## Installing the printer software

**Note:** If you installed the printer software on this computer before but need to reinstall the software, then uninstall the current software first.

- 1 Close all open software programs.
- 2 Insert the installation software CD.  
If the Welcome screen does not appear after a minute, then launch the CD manually:
  - a Click , or click **Start** and then click **Run**.
  - b In the Start Search or Run box, type `D:\setup.exe`, where **D** is the letter of your CD or DVD drive.
- 3 Follow the instructions on the Welcome screen.

## Using the World Wide Web

Updated printer software may be available at [www.support.dell.com](http://www.support.dell.com).

# Loading paper and original documents

## Loading paper

1 Fan the paper.

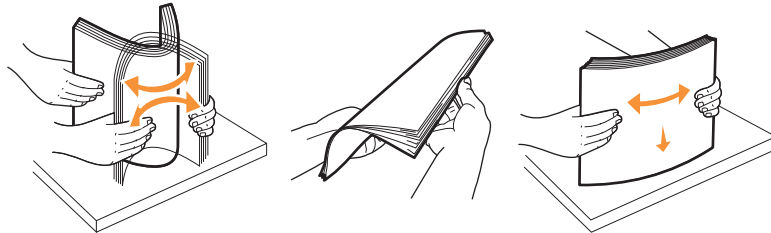

2 Center the paper on the paper support.

3 Adjust the paper guides so they rest against the edges of the paper.

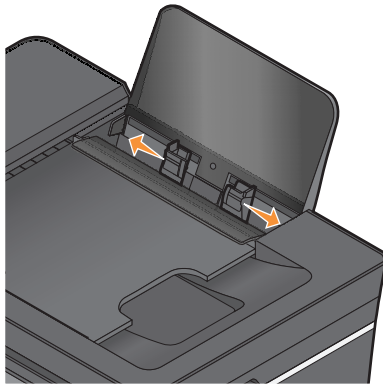

**Note:** Do not force paper into the printer. The paper should be flat against the paper support, and the edges should be flush against both paper guides.

## Paper and specialty media guidelines

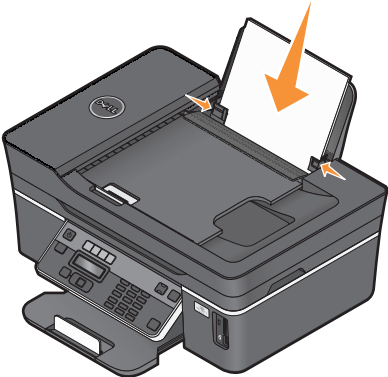
Load up to:	Make sure that:
<p>100 sheets of plain paper</p> 	<ul style="list-style-type: none"><li>• The paper guides rest against the edges of the paper.</li><li>• You load letterhead paper with the print side faceup and the top of the letterhead going into the printer first.</li></ul>

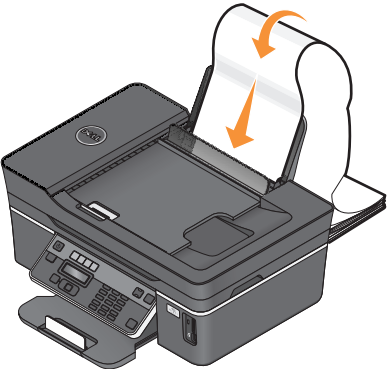
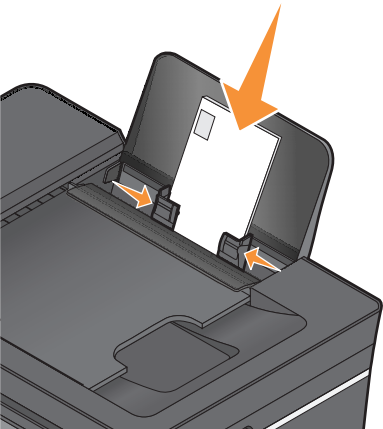
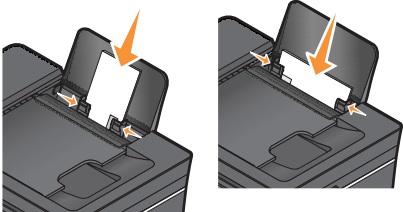
Load up to:	Make sure that:
<p>25 sheets of heavyweight matte paper</p>	<ul style="list-style-type: none"> <li>• The print side of the paper is faceup.</li> <li>• The paper guides rest against the edges of the paper.</li> <li>• You select <b>Automatic</b>, <b>Normal</b>, or <b>Photo</b> print quality.</li> </ul> <p><b>Note:</b> Draft mode is available but is not recommended for use with expensive paper such as heavyweight matte, labels, photo cards and glossy paper.</p>
<p>20 sheets of banner paper</p> 	<ul style="list-style-type: none"> <li>• You remove all paper from the paper support before inserting banner paper.</li> <li>• You use banner paper designed for inkjet printers.</li> <li>• You place a stack of banner paper on or behind the printer, and feed in the first sheet.</li> <li>• The paper guides rest against the edges of the paper.</li> <li>• You select <b>A4 Banner</b> or <b>Letter Banner</b> paper size.</li> </ul>
<p>10 envelopes</p> 	<ul style="list-style-type: none"> <li>• The print side of the envelope is faceup.</li> <li>• The paper guides rest against the edges of the envelopes.</li> <li>• You print the envelopes with <b>Landscape</b> orientation.</li> </ul> <p><b>Note:</b> If you are mailing within Japan, then the envelope can be printed in Portrait orientation with the stamp in the lower right corner or in Landscape orientation with the stamp in the lower left corner. If you are mailing internationally, then print in Landscape orientation with the stamp in the upper left corner.</p>  <ul style="list-style-type: none"> <li>• You select the correct envelope size. Select the next biggest size if the exact envelope size is not listed, and set the left and right margins so your envelope is correctly positioned.</li> </ul>
<p>25 sheets of labels</p>	<ul style="list-style-type: none"> <li>• The print side of the label is faceup.</li> <li>• The paper guides rest against the edges of the paper.</li> <li>• You select <b>Automatic</b>, <b>Normal</b>, or <b>Photo</b> print quality.</li> </ul> <p><b>Note:</b> Draft mode is available but is not recommended for use with expensive paper such as heavyweight matte, labels, photo cards and glossy paper.</p>

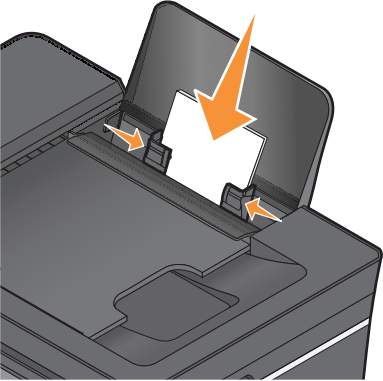
Load up to:	Make sure that:
25 greeting cards, index cards, postcards, or photo cards 	<ul style="list-style-type: none"> <li>The print side of the card is faceup.</li> <li>The paper guides rest against the edges of the cards.</li> <li>You select <b>Automatic</b>, <b>Normal</b>, or <b>Photo</b> print quality.</li> </ul> <p><b>Note:</b> Draft mode is available but is not recommended for use with expensive paper such as heavyweight matte, labels, photo cards and glossy paper.</p>
25 sheets of photo/glossy paper	<ul style="list-style-type: none"> <li>The print side of the paper is faceup.</li> <li>The paper guides rest against the edges of the paper.</li> <li>You select <b>Automatic</b>, <b>Normal</b>, or <b>Photo</b> print quality.</li> </ul> <p><b>Note:</b> Draft mode is available but is not recommended for use with expensive paper such as heavyweight matte, labels, photo cards and glossy paper.</p>
10 iron-on transfers	<ul style="list-style-type: none"> <li>You follow the loading instructions on the iron-on transfer packaging.</li> <li>The print side of the transfer is faceup.</li> <li>The paper guides rest against the edges of the transfer.</li> <li>You select <b>Automatic</b>, <b>Normal</b>, or <b>Photo</b> print quality.</li> </ul>
50 transparencies	<ul style="list-style-type: none"> <li>The rough side of the transparencies is faceup.</li> <li>The paper guides rest against the edges of the transparencies.</li> </ul>

## Saving paper default settings

You can set the default paper size, paper type, and photo print size for the documents and photos that you print.

**Note:** These default settings apply only to print, copy, and scan jobs that you initiate from the printer.

- 1 From the printer control panel, press .
- 2 Choose the default settings:
  - If you want to set the default paper size:
    - a Press **OK** to select **Paper Setup**.
    - b Press the arrow buttons to scroll to **Paper Size**, and then press **OK**.
    - c Press the arrow buttons to select the default paper size for the printer, and then press **OK**.
  - If you want to set the default paper type:
    - a Press **OK** to select **Paper Setup**.
    - b Press the arrow buttons to scroll to **Paper Type**, and then press **OK**.
    - c Press the arrow buttons to select the default paper type for the printer, and then press **OK**.

- If you want to set the default photo print size:
  - a Press the arrow buttons to scroll to **Defaults**, and then press **OK**.
  - b Press **OK** to select **Photo Print Size**.
  - c Press the arrow buttons to select the default photo print size for the printer, and then press **OK**.

3 Press **↶** until you exit Setup, or press another mode button.

## Loading original documents on the scanner glass

- 1 Open the top cover and place the document facedown on the scanner glass.
- 2 Close the top cover.

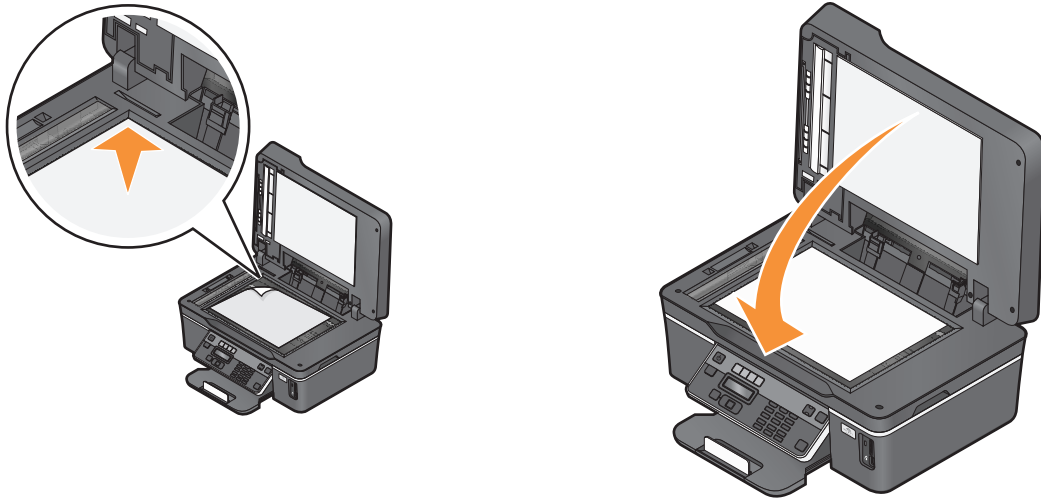

## Loading original documents into the ADF

You can load up to 35 sheets of an original document into the ADF for scanning, copying, and faxing. You can load A4-, letter-, or legal-size paper into the ADF.

- 1 Adjust the paper guide on the ADF tray to the width of the original document.
- 2 Load the original document faceup and top edge first into the ADF until you hear a *beep*.

**3** The document feeds into the ADF.

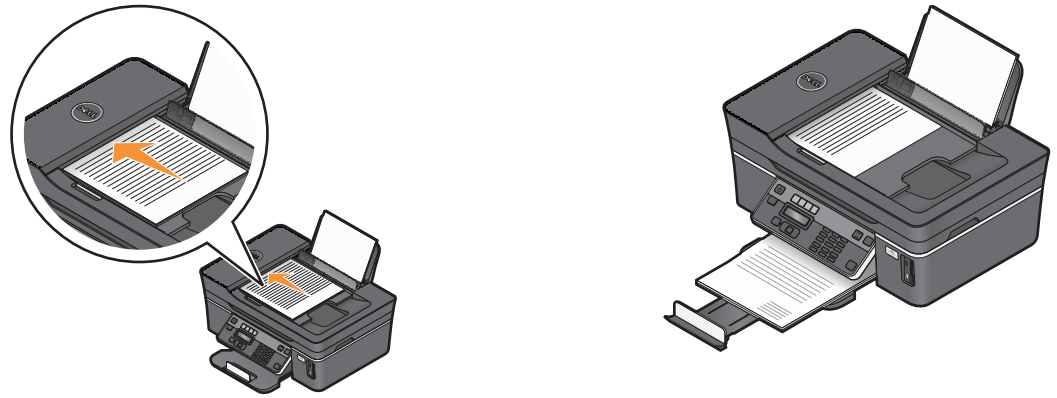

# Printing

## Tips for printing

- Use the appropriate paper for your print job.
- Select a higher print quality for better prints.
- Make sure there is enough ink in the ink cartridges.
- Remove each sheet as it is printed when printing photos or when working with specialty media.
- Select the borderless setting when printing photos.

## Printing basic documents

### Printing a document

- 1 Load the paper in the printer.
- 2 Send the print job:
  - a With a document open, click **File → Print**.
  - b Click **Properties, Preferences, Options, or Setup**.
  - c Select the print quality, the number of copies to print, the type of paper to use, and how the pages should print.
  - d Click **OK** to close any printer software dialogs.
  - e Click **OK** or **Print**.

### Collating printed copies

If you print multiple copies of a document, then you can choose to print each copy as a set (collated) or to print the copies as groups of pages (not collated).

#### Collated



#### Not collated

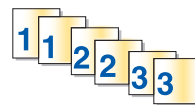

#### Notes:

- The collate option is available only when you are printing multiple copies.
  - To prevent smudging when printing photos, remove each photo as it exits the printer, and then let it dry before stacking.
- 1 With a document open, click **File → Print**.
  - 2 Click **Properties, Preferences, Options, or Setup**.
  - 3 From the Copies section of the Print Setup tab, enter the number of copies that you want to print, and then select **Collate Copies**.

4 Click **OK** to close any printer software dialogs.

5 Click **OK** or **Print**.

## Printing pages in reverse order

By default, the first page is printed first. If you want to reverse the order in which pages print to make documents ready to read with the first page on top, then do the following:

1 With a document open, click **File → Print**.

2 Click **Properties, Preferences, Options, or Setup**.

3 From the Copies section of the Print Setup tab, select a page order:

- To print the last page first, select **Print Last Page First**.
- To print the first page first, clear the **Print Last Page First** check box.

**Note:** If two-sided printing is enabled, then you cannot print the last page first. To change the print order, you must first disable two-sided printing.

4 Click **OK** to close any printer software dialogs.

5 Click **OK** or **Print**.

## Printing multiple pages on one sheet

1 With a document open, click **File → Print**.

2 Click **Properties, Preferences, Options, or Setup**.

3 From the Layout list of the Advanced tab, select **Pages per sheet**.

4 Select the number of page images to print on each page.

If you want each page image to be surrounded by a border, then select **Print Page Borders**.

5 Click **OK** to close any printer software dialogs.

6 Click **OK** or **Print**.

## Printing documents from a memory card or flash drive

To enable the File Print function:

- The printer must be connected to a computer through a USB cable or through a network.
- The printer and the computer must be on.
- The memory card or flash drive must contain document files that are supported by the printer. For more information, see “Supported memory cards and file types” on page 37.
- The computer must contain applications that support the file types in the memory device.

1 Insert a memory card or flash drive.

When the printer detects the memory device, **Memory Card Detected** or **Storage Device Detected** appears on the display.

2 If only document files are stored on the memory device, then the printer automatically switches to File Print mode.

If document files and image files are stored on the memory device, then press **OK** to select **Documents**.



3 Select and print the document:

### If the printer is using a USB connection

- a Press the arrow buttons to select the file name of the document that you want to print or the folder where the document is saved in the memory device.
- b Press **OK**, and then press  to start printing the document.

### If the printer is using a Wireless connection (selected models only)

- a Press the arrow buttons to select the file name of the document that you want to print.
- b Press **OK**, and then wait for the printer to connect to the network computer or to finish searching the network for available computers.
- c When prompted, press the arrow buttons to select the name of the network computer, and then press **OK** to start printing the document.

#### Notes:

- You may be prompted to enter a PIN if the computer requires it. Enter the PIN using the keypad.
- To assign a computer name and a PIN to the computer, see the Help for the printer software associated with your operating system.

## Printing specialty documents

### Printing envelopes

- 1 Load the envelopes in the printer.
- 2 Send the print job:
  - a With a document open, click **File → Print**.
  - b Click **Properties, Preferences, Options, or Setup**.
  - c From the Paper Type list of the Print Setup tab, select **Plain Paper**.
  - d From the Paper Size list, select the envelope size.

**Note:** To print on a custom-size envelope, select **Custom Size**, and then specify the height and width of the envelope.

- e Select an orientation.
- f Click **OK** to close any printer software dialogs.
- g Click **OK** or **Print**.

#### Notes:

- Most envelopes use landscape orientation.
- Make sure the same orientation is also selected in the software application.

## Printing labels

- 1 Load the label sheets in the printer.
- 2 Send the print job:
  - a With a document open, click **File → Print**.
  - b Click **Properties, Preferences, Options, or Setup**.
  - c From the Paper Size list of the Print Setup tab, choose a paper size that matches the size of the label sheet. If no paper size matches the label sheet size, then set a custom size.  
If necessary, choose the appropriate type of paper from the Paper Type list.
  - d Click **OK** to close any printer software dialogs.
  - e Click **OK** or **Print**.

### Tips on loading label sheets

- Make sure the top of the label sheet feeds into the printer first.
- Make sure the adhesive on the labels does not extend to within 1 mm of the edge of the label sheet.
- Make sure the paper guide or paper guides rest against the edges of the label sheet.
- Use full label sheets. Partial sheets (with areas exposed by missing labels) may cause labels to peel off during printing, resulting in a paper jam.

**Note:** Labels require more drying time. Remove each label sheet as it exits, and then allow it to dry to avoid ink smudging.

## Printing on custom-size paper

Before beginning these instructions, load the custom-size paper in the printer.

- 1 With a document open, click **File → Print**.
- 2 Click **Properties, Preferences, Options, or Setup**.
- 3 From the Paper Size list of the Print Setup tab, select **Custom Size**.  
The Define Custom Paper Size dialog appears.
- 4 Set the paper size.
- 5 Select the measurement units to use (inches or millimeters).
- 6 Click **OK** to close any printer software dialogs.
- 7 Click **OK** or **Print**.

## Printing on both sides of the paper (duplexing) manually

- 1 With a document open, click **File → Print**.
- 2 Click **Properties, Preferences, Options, or Setup**.
- 3 Click the **Advanced** tab.

4 From the 2-Sided Printing section, select **Manual**.

**Note:** The Print Instruction Page to Assist in Reloading item is selected automatically.

5 Click **OK**. The printer prints the odd-numbered pages and the instruction sheet.

6 Flip and reload the paper, following the directions on the instruction sheet to complete the print job.

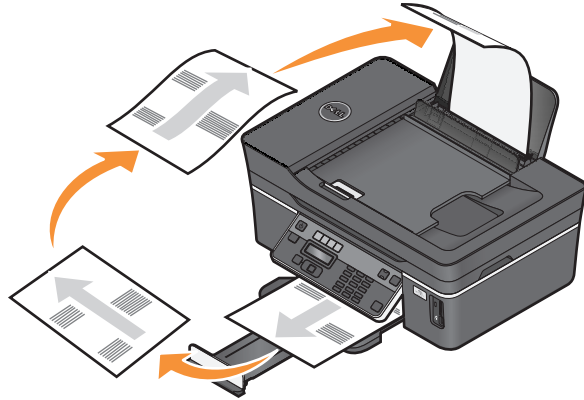

**Note:** To return to single-sided printing, return to the Advanced tab. From the 2-Sided Printing section, select **Off** from the drop-down menu.

# Working with photos

## Using a memory card or flash drive with the printer

Memory cards and flash drives are storage devices frequently used with cameras and computers. You can remove the memory card from the camera or the flash drive from the computer and insert it directly into the printer.

- 1 Insert a memory card into the card slot or a flash drive into the USB port.

### Inserting a memory card

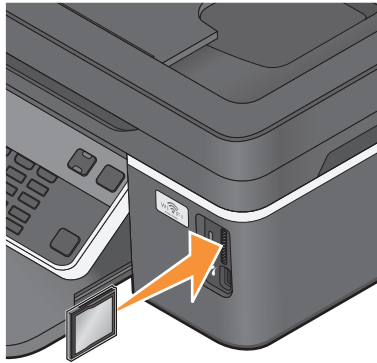

#### Notes:

- Insert the card with the brand name label facing right.
- Make sure any arrows on the card point toward the printer.
- If necessary, connect the memory card to the adapter that came with it.
- Make sure that the memory card inserted is supported by the printer. For more information, see “Supported memory cards and file types” on page 37.

### Inserting a flash drive

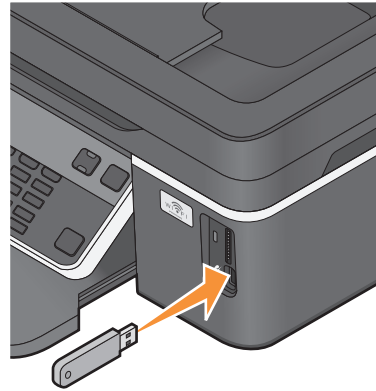

#### Notes:

- The flash drive uses the same port that is used for a PictBridge camera cable.
- An adapter may be necessary if your flash drive does not fit directly into the port.

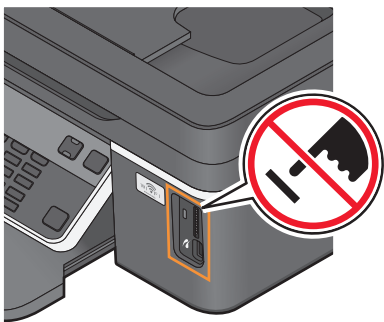

**Warning—Potential Damage:** Do not touch any cables, any network adapter, any connector, the memory device, or the printer in the areas shown while actively printing, reading, or writing from the memory card. A loss of data can occur.

- 2 Look for **Memory Card Detected** or **Storage Device Detected** on the display.

#### Notes:

- If the printer does not recognize the memory device, then remove and reinsert it.
- If a flash drive or a digital camera set to mass storage mode is inserted into the USB port while a memory card is in the card slot, then a message appears on the display prompting you to choose which memory device to use.

## Supported memory cards and file types

Memory Card	File Type
<ul style="list-style-type: none"> <li>Secure Digital (SD)</li> <li>Micro Secure Digital (with adapter) (Micro SD)</li> <li>Mini Secure Digital (with adapter) (Mini SD)</li> <li>MultiMedia Card (MMC)</li> <li>Reduced Size MultiMedia Card (with adapter) (RS-MMC)</li> <li>MultiMedia Card mobile (with adapter) (MMCmobile)</li> <li>Memory Stick</li> <li>Memory Stick PRO</li> <li>Memory Stick Duo (with adapter)</li> <li>Memory Stick PRO Duo (with adapter)</li> <li>xD-Picture Card</li> <li>xD-Picture Card (Type H)</li> <li>xD-Picture Card (Type M)</li> <li>Secure Digital High Capacity (SDHC)</li> </ul>	<p>Documents:</p> <ul style="list-style-type: none"> <li>.doc (Microsoft Word)</li> <li>.xls (Microsoft Excel)</li> <li>.ppt (Microsoft PowerPoint)</li> <li>.pdf (Adobe Portable Document Format)</li> <li>.rtf (Rich Text Format)</li> <li>.docx (Microsoft Word Open Document Format)</li> <li>.xlsx (Microsoft Excel Open Document Format)</li> <li>.pptx (Microsoft PowerPoint Open Document Format)</li> <li>.wpd (WordPerfect)</li> </ul> <p>Images:</p> <ul style="list-style-type: none"> <li>JPEG</li> <li>TIFF</li> </ul>

## Printing photos using the printer control panel

- 1 Load photo paper.
- 2 From the printer control panel, press .
- 3 Insert a memory card, flash drive, or digital camera set to mass storage mode.  
If image files and document files are stored in the memory device, then press the arrow buttons to select **Photos**.
- 4 Press the arrow buttons to scroll to **Easy Photo** or **Print Photos**, and then press **OK**.

### Notes:

- Select **Easy Photo** if you want to print photos quickly.
- Select **Print Photos** if you want to customize the photos before printing them.

- 5 Press the arrow buttons to select a photo printing option, and then press **OK**.

**Note:** You can choose to print the most recent photo, print all the photos, print photos that fall within a date range, print photos by selecting the photo numbers on a proof sheet, or print pre-selected photos from a digital camera using Digital Print Order Format (DPOF). The DPOF option appears only when there is a valid DPOF file in your memory device.

- 6 Adjust the print settings:
  - If you are in the Easy Photo menu, then press the arrow buttons to select the paper size and photo size. Press **OK** each time you make a selection.
  - If you are in the Print Photos menu, then press the arrow buttons to select the photo size, paper size, paper type, layout, photo effects, and quality of the photos, and to adjust the brightness and color effects of the photos. Press **OK** each time you make a selection.

**7** Press the **Color/Black** button to set a color or black-and-white print.

When you select color or black-only printing, the light near your choice comes on.

**8** Press .

**Note:** For best results, allow the prints to dry at least 24 hours before stacking, displaying, or storing.

## Printing photos from a memory device using the printer software

**1** Load photo paper with the glossy or printable side faceup. (If you are not sure which side is the printable side, then see the instructions that came with the paper.)

**2** From the printer control panel, press .

**3** Insert a memory card, flash drive, or digital camera set to mass storage mode.

If document files and image files are stored on the memory device, then press the arrow buttons to scroll to **Photos**. Press .

**4** Transfer or print the photos:

### If the printer is using a USB connection

- Fast Pics launches automatically when you insert the memory device. Follow the instructions on the computer screen to transfer the photos to the computer or to print.

### If the printer is using a Wireless connection (selected models only)

**a** Press the arrow buttons to scroll to **Select Computer**, and then press .

**b** Press the arrow buttons to select the network computer where you want to save the photos, and then press .

**c** Transfer or print the photos:

- Fast Pics launches on the computer. Follow the instructions on the computer screen to transfer the photos to the computer or to print.

## Printing photos from a PictBridge-enabled digital camera

PictBridge is a technology available in most digital cameras that lets you print directly from your digital camera without using a computer.

- 1 Insert one end of the USB cable into the camera.

**Note:** Use only the USB cable that came with the camera.

- 2 Insert the other end of the cable into the PictBridge port on the front of the printer.

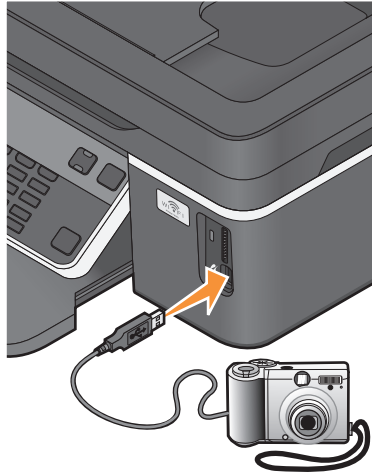

### Notes:

- Make sure that the PictBridge-enabled digital camera is set to the correct USB mode. If the camera USB selection is incorrect, then the camera is detected as a flash drive, or an error message will be displayed on the printer control panel. For more information, see the camera documentation.
- The printer reads only one memory device at a time.

**Warning—Potential Damage:** Do not touch the USB cable, any network adapter, any connector, or the printer in the area shown while actively printing from a PictBridge-enabled digital camera. A loss of data can occur.

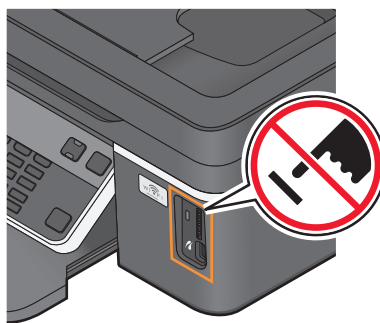

- 3 If the PictBridge connection is successful, then the following message appears on the display: **PictBridge Camera detected. Press OK to change settings.**
- 4 Press **OK** to access the PictBridge menu.

- 5 Press the arrow buttons to select the paper size, paper type, photo size, and layout of the photos that you want to print. Press **OK** each time you make a selection.
- 6 See the documentation for your camera to begin printing.

**Note:** If you insert the camera while the printer is performing another job, then wait for the job to finish before printing from the camera.

## Printing photos from a memory device using the proof sheet

- 1 Load letter- or A4-size plain paper.
- 2 From the printer control panel, press .
- 3 Insert a memory card or flash drive.
- 4 Press the arrow buttons to scroll to **Proof Sheet**, and then press **OK**.
- 5 Press the arrow buttons to select an option to print a proof sheet.

You can print a proof sheet:

- For all photos on the memory device.
- For the 20 most recent photos, if there are 20 or more photos on the memory device.
- By date, if the photos on the card were taken on different dates. If you choose this option, then press the arrow buttons to set the start and end dates, and then press **OK** to save your selections.

- 6 Press .

The proof sheet prints.

- 7 Follow the instructions on the proof sheet to select which photos to print, the number of copies per photo, red-eye reduction, page layout, print options, and paper size.

**Note:** When making selections, make sure to fill in the circles completely.

- 8 Load the proof sheet facedown on the scanner glass.

**Scan Proof Sheet** appears on the display.

**Note:** If this option does not appear on the display, then press the arrow buttons until it appears on the display.

- 9 Press .

The printer scans the proof sheet.

- 10 Load photo paper with the glossy or printable side faceup. (If you are not sure which side is the printable side, then see the instructions that came with the paper.)

**Note:** Make sure that the paper matches the size that you selected on the proof sheet.

- 11 Press the **Color/Black** button to set a color or black-and-white print.

When you select color or black-only printing, the light near your choice comes on.

- 12 Press  to print the photos.



**Note:** To prevent smudging or scratching, avoid touching the printed surface with your fingers or sharp objects. For best results, remove each printed sheet individually from the paper exit tray, and then allow the prints to dry at least 24 hours before stacking, displaying, or storing.



## Printing photos from a digital camera using DPOF

If your camera supports Digital Print Order Format (DPOF), then you can specify which photos to print, how many of each, and the print settings while the memory card is still in the camera. The printer recognizes these settings when you insert the memory card into the printer or connect the camera to the printer.

**Note:** If you specify a photo size while the memory card is still in the camera, then make sure that the size of the paper loaded in the printer is not smaller than the size you specify in the DPOF selection.

- 1 Load photo paper with the glossy or printable side faceup. (If you are not sure which side is the printable side, then see the instructions that came with the paper.)
- 2 From the printer control panel, press .
- 3 Insert a memory card.  
**Memory Card Detected** appears on the display.
- 4 Press the arrow buttons to scroll to **Print Photos**, and then press **OK**.
- 5 Press the arrow buttons to scroll to **Print DPOF**, and then press  to print the photos.

**Note:** This option appears only if a DPOF file is detected in the memory card.

**Note:** To prevent smudging or scratching, avoid touching the printed surface with your fingers or sharp objects. For best results, remove each printed sheet individually from the paper exit tray, and allow the prints to dry at least 24 hours before stacking, displaying, or storing.

## Printing from a Bluetooth-enabled device

- This printer is compliant with Bluetooth Specification 2.0. It supports the following profiles: Object Push Profile (OPP) and Serial Port Profile (SPP). Check with your Bluetooth-enabled device manufacturers (cellular phone or PDA) to determine their hardware compatibility and interoperability. It is recommended that you use the latest firmware on your Bluetooth-enabled device.
- To print Microsoft documents from your Windows Mobile/Pocket PC PDA, additional third-party software and drivers are required. For more information about the required software, see the documentation for your PDA.

## Setting up a connection between your printer and a Bluetooth-enabled device

**Note:** The printer does not support printing files from your computer using a Bluetooth connection.

You need to set up a connection between a Bluetooth-enabled device and your printer if you are sending a print job from the Bluetooth device for the first time. You will need to repeat the setup if:

- You reset the printer to its factory default settings.
- You change the Bluetooth security level or the Bluetooth pass key.

- The Bluetooth-enabled device you are using requires users to set up a Bluetooth connection on every print job. For more information, see the documentation for your Bluetooth device.
- The name of the Bluetooth device you are using is automatically deleted from the Bluetooth device list.

When the Bluetooth security level is set to High, the printer saves a list of up to eight Bluetooth devices that have previously set up a connection with the printer. When the printer detects more than eight devices, the least recently used device is removed from the list. You need to repeat the setup of the deleted device to be able to send a print job to the printer.

**Note:** You need to set up a connection for each Bluetooth device that you use to send a print job to the printer.

To set up a connection between the printer and a Bluetooth-enabled device:

- 1 Insert a USB Bluetooth adapter into the USB port located on the front of the printer.

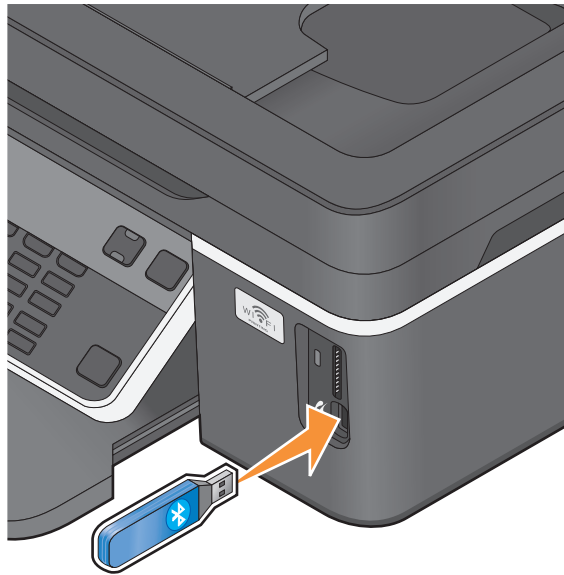

**Bluetooth Dongle Connected** appears on the display.

**Note:** A Bluetooth adapter is not included with the printer.

- 2 From the printer control panel, press .
- 3 Press the arrow buttons to scroll to **Bluetooth Setup**, and then press **OK**.
- 4 Press the arrow buttons to scroll to **Discovery**, and then press **OK**.
- 5 Make sure Discovery is set to On. If necessary, press the arrow buttons to scroll to **On**, and then press **OK**.  
The printer is now ready to accept a connection from a Bluetooth-enabled device.
- 6 Configure the Bluetooth-enabled device to set up a connection to the printer. For more information, see the documentation for your Bluetooth device.

**Note:** If the Bluetooth Security Level on the printer is set to High, then you must enter a pass key.

## Setting the Bluetooth security level

- 1 Insert a Bluetooth USB adapter into the USB port.

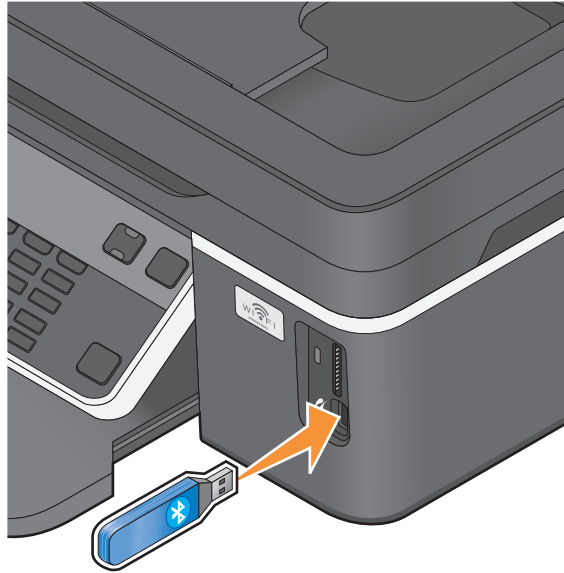

**Bluetooth Dongle Connected** appears on the display.

**Note:** A Bluetooth adapter is not included with the printer.

- 2 From the printer control panel, press .
- 3 Press the arrow buttons to scroll to **Bluetooth Setup**, and then press button **OK**.
- 4 Press the arrow buttons to scroll to **Security Level**, and then press **OK**.
- 5 Press the arrow buttons to select the security level, and then press **OK**.
  - Select **Low** to allow Bluetooth devices to connect and send print jobs to your printer without requiring users to enter a pass key.
  - Select **High** to require users to enter a four-digit numeric pass key on the Bluetooth device before connecting and sending print jobs to the printer.
- 6 The Bluetooth Pass Key menu appears on the display if you set the security level to High. Use the keypad to enter your four-digit pass key, and then press **OK**.

## Printing from a Bluetooth-enabled device

**Note:** The printer does not support printing files from your computer using a Bluetooth connection.

- 1 Insert a USB Bluetooth adapter into the USB port.

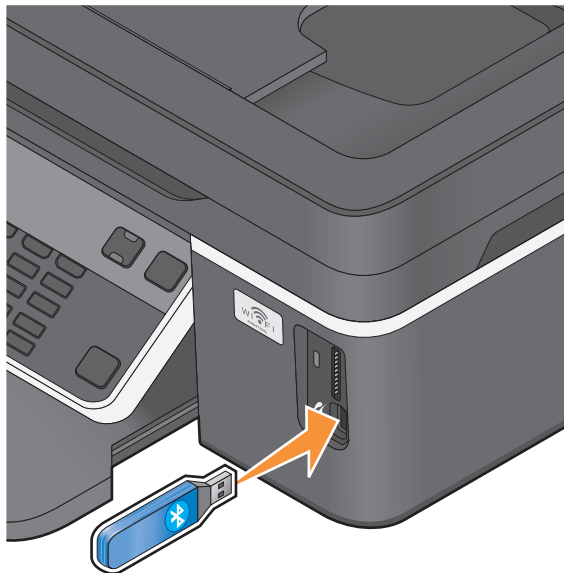

**Bluetooth Dongle Connected** appears on the display.

**Warning—Potential Damage:** Do not touch cables, any network adapter, any connector, the USB Bluetooth adapter, or the printer in the areas shown while actively printing, reading, or writing from a Bluetooth-enabled device. A loss of data can occur.

**Notes:**

- A Bluetooth adapter is not included with the printer.
  - Your printer automatically switches to Bluetooth mode when you insert a USB Bluetooth adapter.
- 2 Make sure the printer is set up to receive Bluetooth connections. For more information, see “Setting up a connection between your printer and a Bluetooth-enabled device” on page 41.
  - 3 Set up the Bluetooth device to print to the printer. For more information, see the documentation for your Bluetooth device.
  - 4 See the documentation for your Bluetooth device to begin printing.

**Note:** If the Bluetooth Security Level on the printer is set to High, you must enter a pass key.

## Managing print jobs

### Setting your printer as the default printer

Your printer should be selected automatically from the Print dialog when you send a print job. If you have to manually select your printer, then it is not the default printer.

To set the default printer:

- 1 Click , or click **Start** and then click **Run**.
- 2 In the Start Search or Run box, type **control printers**.

**3** Press **Enter**, or click **OK**.

The printer folder opens.

**4** Right-click the printer, and then select **Set as Default Printer**.

## Changing the printing mode

To conserve ink, you can change the default printing mode for all print jobs to Quick Print. It uses less ink and is ideal for printing text-only documents. If you need to change to a different print mode to print photos or other high-quality documents, then you can select a different mode from the Print dialog before sending the print job.

To change the default print mode:

**1** Click , or click **Start** and then click **Run**.

**2** In the Start Search or Run box, type `control printers`.

**3** Press **Enter**, or click **OK**.

The printer folder opens.

**4** Right-click the printer, and then select **Printing Preferences**.

**5** Select **Quick Print** as the printing mode.

## Changing the printing mode for a single print job

**1** With a document open, click **File** → **Print**.

**2** Click **Properties**, **Preferences**, **Options**, or **Setup**.

**3** Select **Automatic**, **Quick Print**, **Normal**, or **Best**.

**Note:** Printing in Draft mode uses less ink and is ideal for printing text documents.

## Pausing print jobs

**1** Click , or click **Start** and then click **Run**.

**2** In the Start Search or Run box, type `control printers`.

**3** Press **Enter**, or click **OK**.

The printer folder opens.

**4** Right-click the printer, and then select **Pause Printing**.

## Resuming print jobs

**1** Click , or click **Start** and then click **Run**.

**2** In the Start Search or Run box, type `control printers`.

**3** Press **Enter**, or click **OK**.

The printer folder opens.

**4** Right-click the printer, and then select **Open**.

**5** Resume the print job:

- If you want to resume a particular print job, then right-click the document name, and then select **Resume**.
- If you want to resume all print jobs in the queue, then click **Printer**, and then clear the selection for Pause Printing.

## Canceling print jobs

To cancel a print job from the printer control panel, press **X**. To cancel a print job from the computer, do the following:

**1** Click , or click **Start** and then click **Run**.

**2** In the Start Search or Run box, type **control printers**.

**3** Press **Enter**, or click **OK**.

The printer folder opens.

**4** Right-click the printer, and then select **Open**.

**5** Cancel the print job:

- If you want to cancel a particular print job, then right-click the document name, and then select **Cancel**.
- If you want to cancel all print jobs in the queue, then click **Printer** → **Cancel All Documents**.

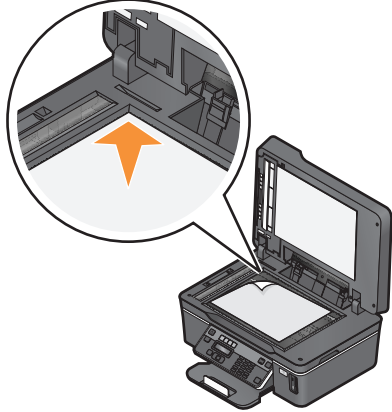

# Copying

ADF	Scanner glass
 <p>Use the ADF for multiple-page documents.</p> <p><b>Note:</b> The ADF is available only on selected models. If you purchased a printer without an ADF, then load original documents or photos on the scanner glass.</p>	 <p>Use the scanner glass for single pages, small items (such as postcards or photos), transparencies, photo paper, or thin media (such as magazine clippings).</p>

## Tips for copying





- When using the ADF, adjust the paper guide on the ADF to the width of the original document.
- When using the scanner glass, close the top cover to avoid dark edges on the scanned image.
- Do *not* load postcards, photos, small items, transparencies, photo paper, or thin media (such as magazine clippings) into the ADF. Place these items on the scanner glass.

## Making copies

- 1 Load paper.
- 2 Load an original document faceup into the ADF or facedown on the scanner glass.
- 3 From the printer control panel, press .
- 4 Press the arrow buttons to select the number of copies, and then press the **Color/Black** button to set a color or black-and-white copy.  
When you select color or black-only printing, the light near your choice comes on.
- 5 Press .



## Copying photos

- 1 Load photo paper with the glossy or printable side faceup. (If you are not sure which side is the printable side, then see the instructions that came with the paper.)
- 2 Place a photo facedown on the scanner glass.



- 3 From the printer control panel, press .
- 4 Press  until **Photo Reprint** appears.
- 5 Press the arrow buttons to scroll to **Yes**, and then press .
- 6 Press the arrow buttons to select the desired paper size, and then press .
- 7 Press .

**Note:** To prevent smudging or scratching, avoid touching the printed surface with your fingers or sharp objects. For best results, remove each printed sheet individually from the paper exit tray, and allow the prints to dry at least 24 hours before stacking, displaying, or storing.

## Enlarging or reducing images

- 1 Load paper.
- 2 Load an original document facedown on the scanner glass.
- 3 From the printer control panel, press .
- 4 Press  until **Resize** appears.
- 5 Press the arrow buttons until the setting that you want appears.





### Notes:

- If you select Custom % Resize, then press , and then press the arrow buttons to select the desired custom percent value. Press  to save the setting.
- If you select Borderless, then the printer will reduce or enlarge the document or photo as necessary to print a borderless copy on the paper size that you selected. For best results with this resize setting, use photo paper and set the paper type to Photo, or let the printer automatically detect the paper type.

- 6 Press .

**Note:** After the copy job is finished, press  to reset the settings to the default. The resize setting also switches to 100% after two minutes of printer inactivity.

## Adjusting copy quality

- 1 Load paper.
- 2 Load an original document faceup into the ADF or facedown on the scanner glass.
- 3 From the printer control panel, press .
- 4 Press  until **Quality** appears.
- 5 Press the arrow buttons to set the copy quality to Automatic, Draft, Normal, or Photo, and then press  to save your setting.
- 6 Press .



# Making a copy lighter or darker

- 1 Load paper.
- 2 Load an original document faceup into the ADF or facedown on the scanner glass.
- 3 From the printer control panel, press .
- 4 Press **OK** until **Lighter/Darker** appears.
- 5 Press the arrow buttons to adjust the slider, and then press **OK** to save your setting.

**Note:** Pressing the left arrow button makes the copy lighter, and pressing the right arrow button makes the copy darker.

- 6 Press .

# Collating copies using the printer control panel



If you print multiple copies of a document, then you can choose to print each copy as a set (collated) or to print the copies as groups of pages (not collated).

## Collated





## Not collated



- 1 Load paper.
- 2 Load an original document faceup into the ADF or facedown on the scanner glass.
- 3 From the printer control panel, press .
- 4 Press the arrow buttons to select the number of copies, and then press **OK**.
- 5 Press **OK** until **Collate** appears.
- 6 Press the arrow buttons to scroll to **On**.
- 7 Press  to save the image to the printer memory.
- 8 When asked if you want to scan another page, press **OK** to select **Yes**.
- 9 Load the next page of the original document faceup into the ADF or facedown on the scanner glass, and then press **OK**.
- 10 Repeat steps 8 and 9 until all the pages that you want to copy have been saved to the printer memory.
- 11 When asked if you want to scan another page, press the arrow buttons to scroll to **No**, and then press **OK** to start printing the copies.



# Repeating an image on one page

You can print the same page image multiple times on one sheet of paper. This option is helpful when creating items such as labels, decals, flyers, and handouts.

- 1 Load paper.
- 2 Load an original document facedown on the scanner glass.
- 3 From the printer control panel, press .
- 4 Press **OK** until **Copies per Sheet** appears.
- 5 Press the arrow buttons to select the number of times that an image is repeated on a page: once, four times, nine times, or 16 times.
- 6 Press .

# Copying multiple pages on one sheet

The Pages per Sheet setting lets you copy multiple pages on one sheet by printing smaller images of each page. For example, you can condense a 20-page document into five pages if you use this setting to print four page images per sheet.

- 1 Load paper.
- 2 Load an original document faceup into the ADF or facedown on the scanner glass.
- 3 From the printer control panel, press .
- 4 Press **OK** until **Pages per Sheet** appears.
- 5 Press the arrow buttons to select the number of pages that you want to copy on a sheet of paper. You may choose to copy one, two, or four page images on a sheet.  
**Note:** If you are copying four pages in landscape format, scan pages 3 and 4 first, and then scan pages 1 and 2.
- 6 Press  to save the image of the page to the printer memory.
- 7 When asked if you want to scan another page, press **OK** to select **Yes**.
- 8 Load the next page of the original document faceup into the ADF or facedown on the scanner glass, and then press **OK**.
- 9 Repeat steps 7 and 8 until all the pages that you want to copy have been saved to the printer memory.
- 10 When asked if you want to scan another page, press the arrow buttons to scroll to **No**, and then press **OK** to start printing.

# Making a duplex copy manually

- 1 Load paper.
- 2 Load an original document faceup into the ADF or facedown on the scanner glass.
- 3 From the printer control panel, press .

**4** Press the left or right arrow button to select the number of copies, and then press the **Color/Black** button to set a color or black-and-white copy.

When you select color or black-only printing, the light near your choice comes on.

**5** Press .

**6** Load the next page of the document.

- If you are copying a one-sided document, then load the next page faceup into the ADF or facedown on the scanner glass.
- If you are copying a two-sided document, then flip the original document, and then reload it faceup into the ADF or facedown on the scanner glass.

**7** Remove the paper from the paper exit tray, and then reload the paper to print the other side of the document.

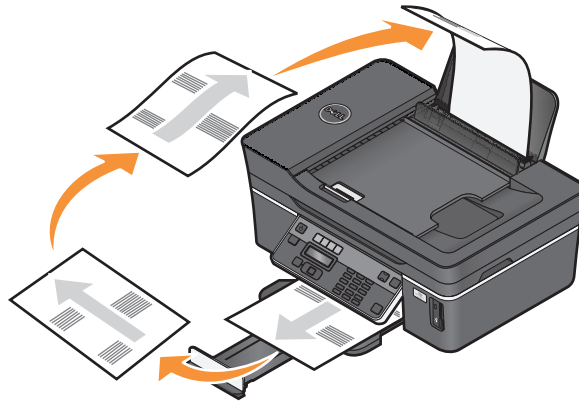

**8** Press .

## Canceling copy jobs

To cancel a copy job, press .

Scanning stops and the printer returns to the previous menu.

# Scanning

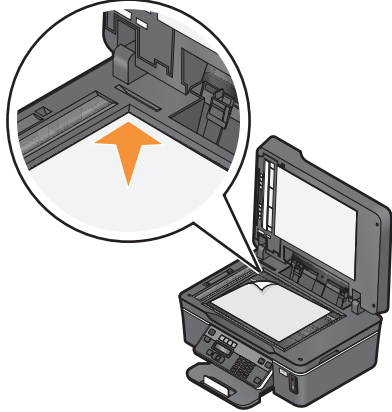
ADF	Scanner glass
 <p>Use the ADF for multiple-page documents.</p> <p><b>Note:</b> The ADF is available only on selected models. If you purchased a printer without an ADF, then load original documents or photos on the scanner glass.</p>	 <p>Use the scanner glass for single pages, small items (such as postcards or photos), transparencies, photo paper, or thin media (such as magazine clippings).</p>

## Tips for scanning

- When using the ADF, adjust the ADF paper guide to the width of the original document.
- When using the scanner glass, close the scanner lid to avoid dark edges on the scanned image.
- Do *not* load postcards, photos, small items, transparencies, photo paper, or thin media (such as magazine clippings) into the ADF. Place these items on the scanner glass.
- Select the PDF file type if you want to scan multiple pages and save them as one file.

## Scanning to a local or network computer

- 1 Load an original document faceup into the ADF or facedown on the scanner glass.
- 2 From the printer control panel, press .
- 3 Press the arrow buttons to scroll to **Computer** or **Network**, and then press **OK**.
- 4 Press the arrow buttons to select the name of a local or network computer, and then press **OK**.  
The local or network computer is the destination that will receive the scan.

### Notes:



- You may be prompted to enter a PIN if the computer requires it. Enter the PIN using the keypad.
  - To assign a computer name and a PIN to the computer, see the Help for the printer software associated with your operating system.
- 5 Wait until the printer has finished downloading a list of the scan applications available on the selected computer.
  - 6 Press the arrow buttons to select an application, and then press **OK**.

- 7 Press the arrow buttons to select the resolution quality and the original image size. Press **OK** each time you make a selection.
- 8 Press  to start scanning.

The scan is complete when the application you selected in step 6 opens on the destination computer, and the scan appears within the application as a new file.

## Scanning to a flash drive or memory card



Before you begin, make sure your flash drive or memory card is not write protected.

- 1 Load an original document faceup into the ADF or facedown on the scanner glass.
- 2 From the printer control panel, press .
- 3 When **Scan to** appears on the display, insert the flash drive or memory card.
- 4 Press the arrow buttons to scroll to **USB Flash Drive** or **Memory Card**, and then press **OK**.
- 5 Press the arrow buttons to select the resolution quality, the type of output you want to create, and the original image size. Press **OK** each time you make a selection.
- 6 Press  to start scanning.

The scan is complete when a message appears on the printer control panel indicating that the file you scanned has been saved.

## Scanning photos into an editing application

### Using the printer control panel

- 1 Load the photo or photos facedown on the scanner glass.
- 2 From the printer control panel, press .
- 3 Press the arrow buttons to scroll to **Computer** or **Network**, and then press **OK**.
- 4 Press the arrow buttons to select the name of a local or network computer, and then press **OK**.  
The local or network computer is the destination that will receive the scan.
- 5 Wait until the printer has finished downloading the list of scan applications available on the selected computer.
- 6 Press the arrow buttons to select a photo editing application, and then press **OK**.
- 7 Press the arrow buttons to select the resolution quality, the type of output you want to create, and the original image size. Press **OK** each time you make a selection.
- 8 Press  to start scanning.
- 9 When asked if you want to scan another page, press **OK** to select **Yes**.
- 10 Load the next photo or photos facedown on the scanner glass, and then press **OK**.
- 11 Repeat steps 9 and 10 until all the photos that you want to scan are saved to the printer memory.
- 12 When asked if you want to scan another page, press the arrow buttons to scroll to **No**, and then press **OK**.

The scan is complete when the photo editing application you selected in step 6 opens on the destination computer, and the scan appears within the application as a new file.

## Using the printer software

- 1 Load a photo or photos facedown on the scanner glass.
- 2 Click  or **Start**.
- 3 Click **All Programs** or **Programs**, and then select the printer program folder from the list.
- 4 Select **Printer Home**.
- 5 Choose your printer from the printer drop-down list.
- 6 Click **Photo**.
  - If you want to scan a single photo, or multiple photos as a single image, then select **Single photo**.
  - If you want to scan multiple photos at once and save them as separate images, then select **Split into individual photos**.Scanning starts and the scan progress dialog appears.
- 7 Save the photo or photos and open in a photo editing application to edit.

## Scanning documents into an editing application

An Optical Character Recognition (OCR) application allows you to edit an original text document that has been scanned. In order for this to work, you must have an OCR application stored on a local or network computer and you must be able to choose it from the list of applications when you set up the scan.

When selecting settings for the scan:

- Select to scan to the local computer or network computer where the OCR is installed.
  - Select to scan to the highest resolution.
- 1 Load an original document faceup into the ADF or facedown on the scanner glass.
  - 2 Click  or **Start**.
  - 3 Click **All Programs** or **Programs**, and then select the printer program folder from the list.
  - 4 Select **Printer Home**.
  - 5 Choose your printer from the printer drop-down list.
  - 6 Click **Document**.  
Scanning starts and the scan progress dialog appears.
  - 7 When the scan is finished, save the document in a word-processing application.
  - 8 Open the document in the selected application to edit it.

## Scanning directly to e-mail

- 1 Load an original document faceup into the ADF or facedown on the scanner glass.
- 2 Click  or **Start**.

- 3** Click **All Programs** or **Programs**, and then select the printer program folder from the list.
- 4** Select **Printer Home**.
- 5** Choose your printer from the printer drop-down list.
- 6** Click **Email**, and then select **Photo**, **Document** or **PDF**.  
Scanning starts and the scan progress dialog appears.
- 7** When the scan is finished, a new e-mail message is created with the scanned document automatically attached.
- 8** Compose your e-mail message.

**Note:** If your e-mail program does not open automatically, then you can scan the document to the computer and then send it through e-mail as an attachment.

## Scanning to a PDF

- 1** Load an original document faceup into the ADF or facedown on the scanner glass.
- 2** Click  or **Start**.
- 3** Click **All Programs** or **Programs**, and then select the printer program folder from the list.
- 4** Select **Printer Home**.
- 5** Choose your printer from the printer drop-down list.
- 6** Click **PDF**.  
Scanning starts and the scan progress dialog appears.
- 7** Save the document as a PDF.

## Scanning FAQ

### How can I improve the quality of a scan?

- Make sure your original documents are in good condition.
- Make sure the application that receives the scanned document is appropriate. For example, if you are scanning a photo to edit it, then make sure you choose a photo editing application to receive the scan. If you are scanning a document to edit the text, then make sure you choose an OCR application.
- Use a high resolution.

### How do I scan in black and white?

Color is the default for all scans. To scan in black and white, press the **Color/Black** button on the printer control panel to switch from color to black and white.

### Why am I being asked for a PIN?

PINs are a security measure used to restrict the scanned information from going into certain locations, or to keep what is being scanned from being seen or used by others. You may be prompted to enter a PIN if the network computer you are scanning to requires one.

To learn how PINs get assigned to network computers, see the Help for the printer software associated with your operating system.

## What is an application list, and how do I update it?

When you scan a file, you can choose which application to use to open it on your computer. The printer downloads this application list from your computer when scanning for the first time. If you do not see the application you want on the list, or if you install new applications on your computer, then update the application list in the printer.

### Updating the application list

- 1 From the printer control panel, press .
- 2 Press the arrow buttons to scroll to **Computer** or **Network**.
- 3 Select a local or network computer to receive the scan and then press **OK**.
- 4 Select **REFRESH** from the list of scan applications.  
This updates the application list in the printer.

## Canceling scan jobs

Press **X** on the printer control panel, or click **Cancel** on the computer screen.



# Faxing

**CAUTION—SHOCK HAZARD:** Do not use the fax feature during a lightning storm. Do not set up this product or make any electrical or cabling connections, such as the power supply cord or telephone, during a lightning storm.

## Setting up the printer to fax

### Scenario 1: Standard telephone line

Check the scenarios below and follow the setup that is applicable to your telephone line.

#### Setup 1: Printer is connected to a dedicated fax line

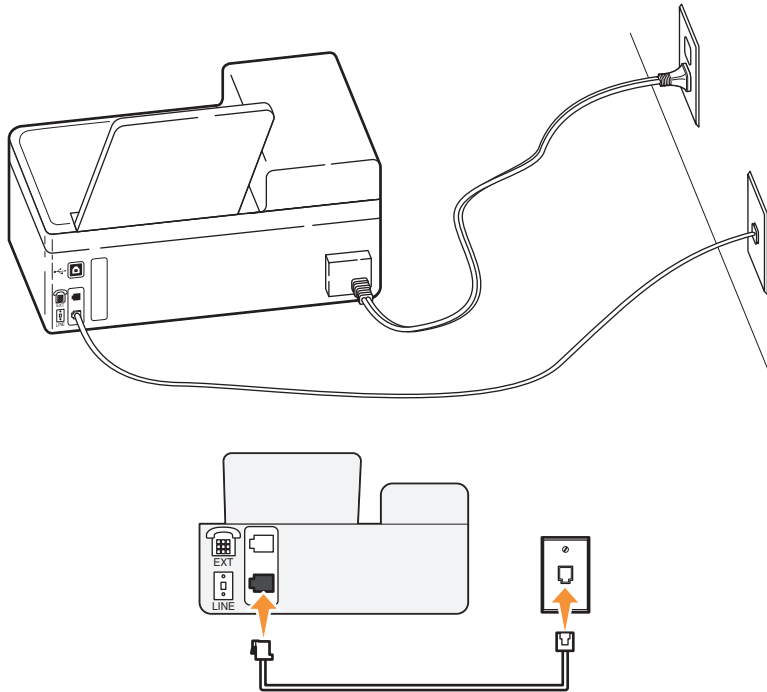

#### Tips for this setup:

- You can set the printer to receive faxes automatically (Auto Answer On) or manually (Auto Answer Off).
- If you want to receive faxes automatically (Auto Answer On), then you may set the printer to pick up on any number of rings that you want.

## Setup 2: Printer is sharing the line with an answering machine

Connected to the same telephone wall jack

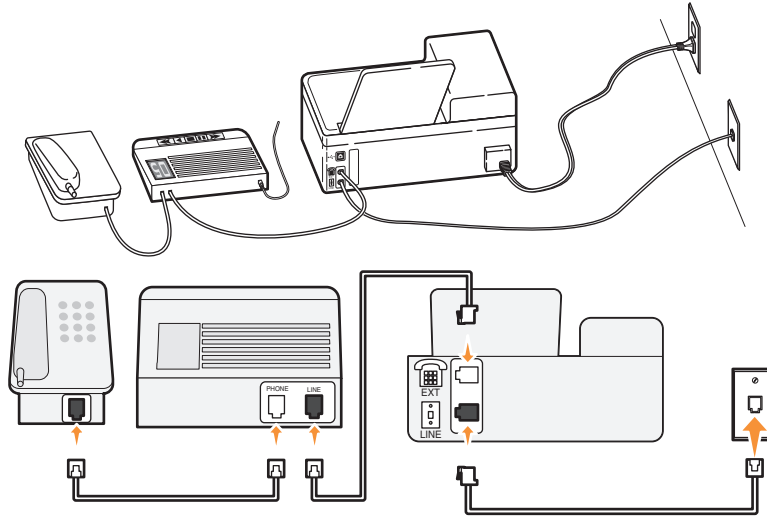

Connected to different wall jacks

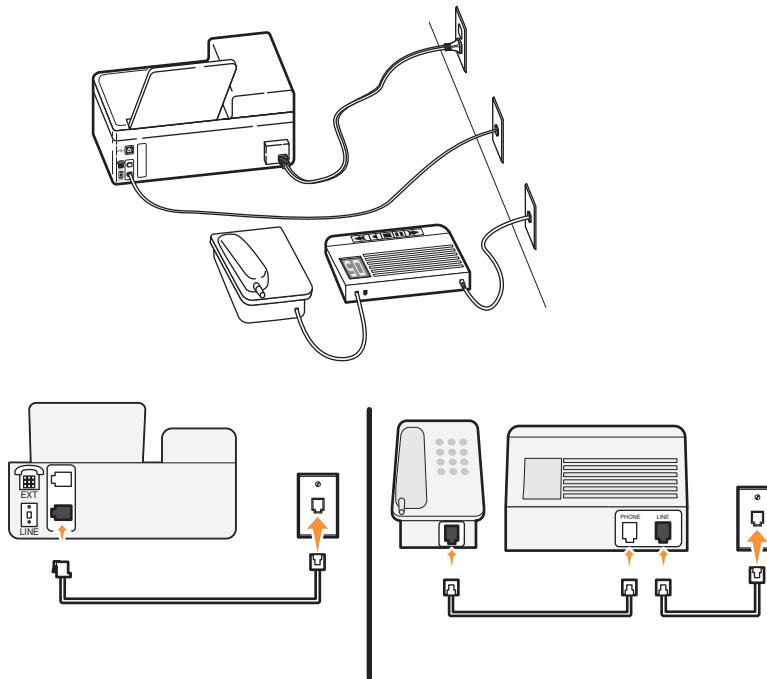

### Tips for this setup:

- If you have only one telephone number on your line, or if you do not subscribe to a distinctive ring service, then you need to set the printer to receive faxes automatically (Auto Answer On).
- Set the printer to pick up calls two rings after the answering machine. For example, if the answering machine picks up calls after four rings, then set the printer to pick up after six rings. This way, the answering machine picks up calls first and your voice calls are received. If the call is a fax, then the printer detects the fax signal on the line and takes over the call.

- If you subscribe to a distinctive ring service provided by your telephone company, then make sure that you set the correct ring pattern for the printer. Otherwise, the printer will not receive faxes even if you have set it to receive faxes automatically.

### Setup 3: Printer is sharing the line with a telephone subscribed to voice mail service

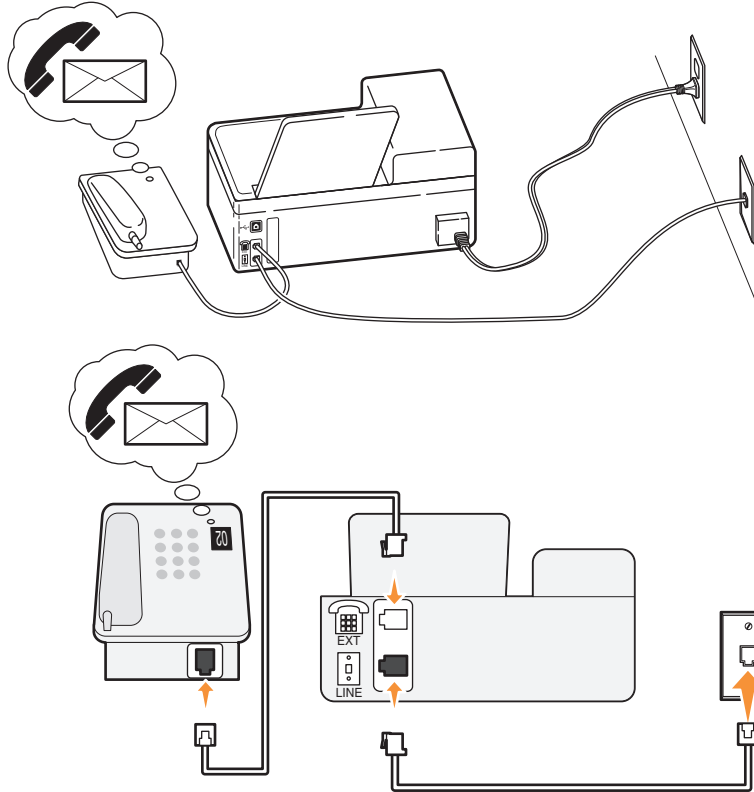

#### Tips for this setup:

- This setup works best if you subscribe to a distinctive ring service. If you have distinctive ring service, then make sure that you set the correct ring pattern for the printer. Otherwise, the printer will not receive faxes even if you have set it to receive faxes automatically.
- If you have only one telephone number on your line, or if you do not have distinctive ring service, then you need to set the printer to receive faxes manually (Auto Answer Off).

When you answer the telephone and you hear fax tones, press \*9\* or the manual answer code on the telephone to receive the fax.

- You can also set the printer to receive faxes automatically (Auto Answer On), but you need to turn off the voice mail service when you are expecting a fax. This setting works best if you are using voice mail more often than fax.

## Scenario 2: Digital Subscriber Line (DSL)

Follow this setup if you have a Digital Subscriber Line (DSL).

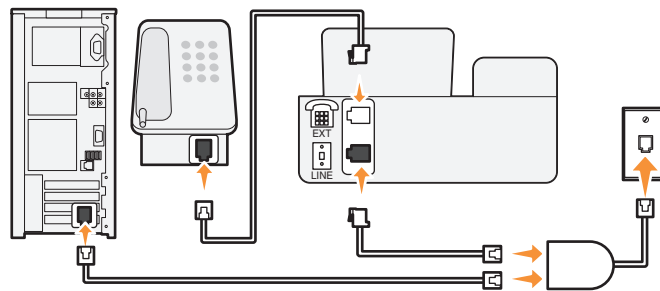
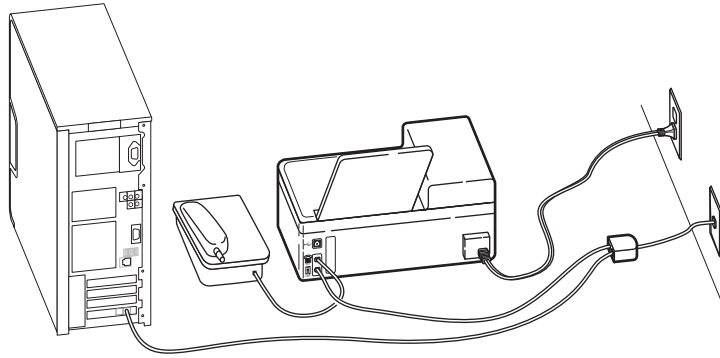

A Digital Subscriber Line splits your regular telephone line into two channels: voice and Internet. Telephone and fax signals travel through the voice channel, and Internet signals pass through the other channel. This way, you can use the same line for analog voice calls (including faxing) and digital Internet access.

To minimize interference between the two channels and ensure a quality connection, you need to install a DSL filter for the analog devices (fax machine, telephone, answering machine) in your network. Interference causes noise and static on the telephone, failed and poor quality faxes for the printer, and slow Internet connection on your computer.

To install a filter for the printer:

- 1 Connect the line port of the DSL filter to the wall jack.
- 2 Connect a telephone cable from the  port on the back of the printer to the phone port on the DSL filter.
- 3 To continue using a computer for Internet access, connect the computer to the DSL HPN port on the DSL filter.

## Scenario 3: VoIP telephone service

Follow this setup if you have telephone service from a Voice over Internet Protocol (VoIP) provider.

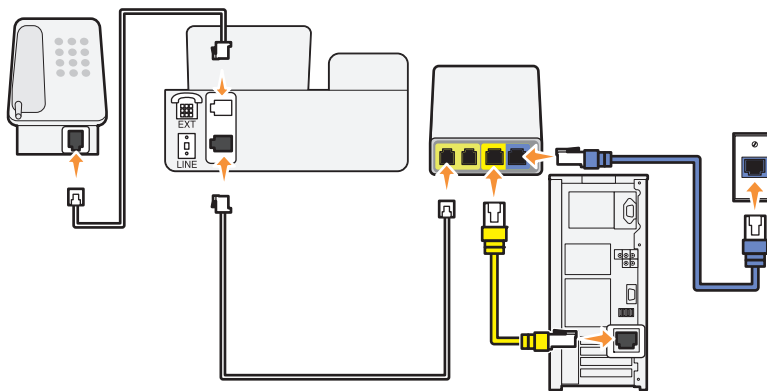
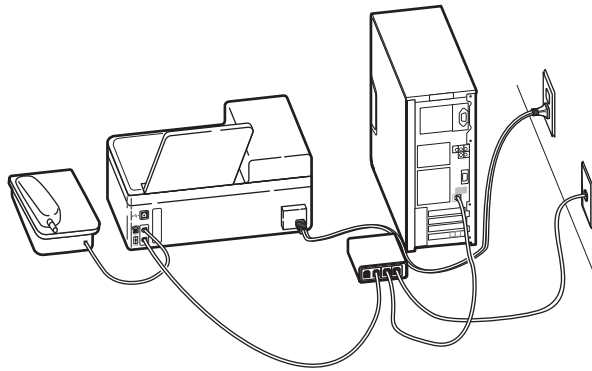

### Tips for this setup:

- Connect the printer to the port labeled **Phone Line 1** or **Phone Port** on the VoIP adapter. The port labeled **Phone Line 2** or **Fax Port** is not always active. You may need to pay extra to your VoIP provider if you want to activate the second phone port.
- To make sure that the phone port on the VoIP adapter is active, plug an analog telephone into the phone port, and then listen for a dial tone. If you hear a dial tone, then the port is active.
- If you need two phone ports for your devices but do not want to pay extra, then do not plug the printer into the second phone port. You can use a phone splitter. Plug the phone splitter into the **Phone Line 1** or **Phone Port**, and then plug the printer and telephone into the splitter.

**Note:** Make sure you use a phone splitter, *not* a line splitter. To make sure that you are using the correct splitter, plug an analog telephone into the splitter and then listen for a dial tone.

## Scenario 4: Digital telephone service through a cable provider

### Setup 1: Printer is connected directly to a cable modem

Follow this setup if you normally connect your telephone to a cable modem.

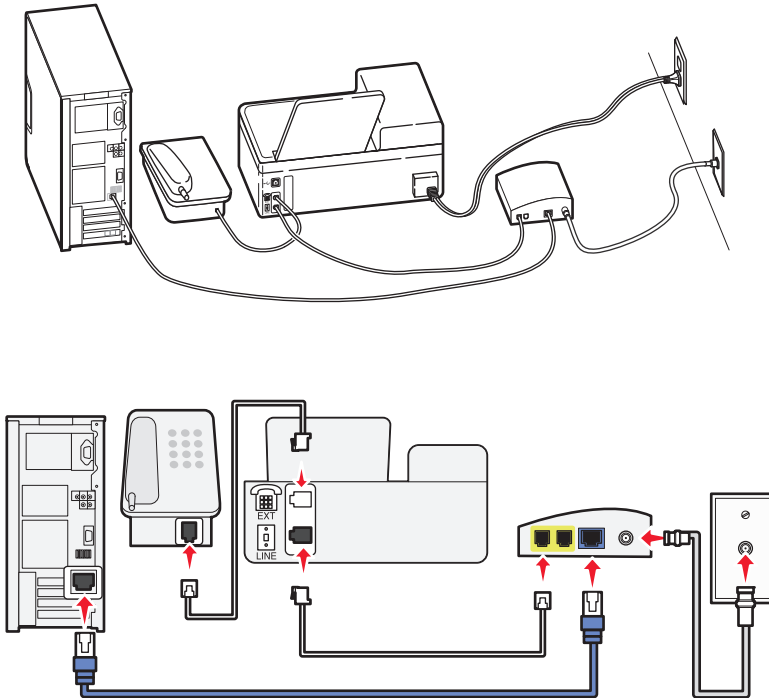

#### Tips for this setup:

- Connect the printer to the port labeled **Phone Line 1** or **Phone Port** on the cable modem. The port labeled **Phone Line 2** or **Fax Port** is not always active. You may need to pay extra to your cable provider if you want to activate the second phone port.
- To make sure that the phone port on the cable modem is active, plug an analog telephone into the phone port, and then listen for a dial tone. If you hear a dial tone, then the port is active.
- If you need two phone ports for your devices but do not want to pay extra, then do not plug the printer into the second phone port. You can use a phone splitter. Plug the phone splitter into the **Phone Line 1** or **Phone Port**, and then plug the printer and telephone into the splitter.

**Note:** Make sure you use a phone splitter, *not* a line splitter. To make sure that you are using the correct splitter, plug an analog telephone into the splitter and then listen for a dial tone.

## Setup 2: Printer is connected to a wall jack; cable modem is installed elsewhere in the house

Follow this setup if your cable provider activated the wall jacks in your house so that you do not have to plug your devices into the cable modem. Your cable telephone service comes from the wall jacks.

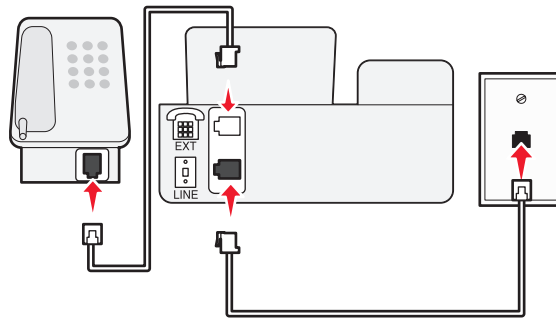
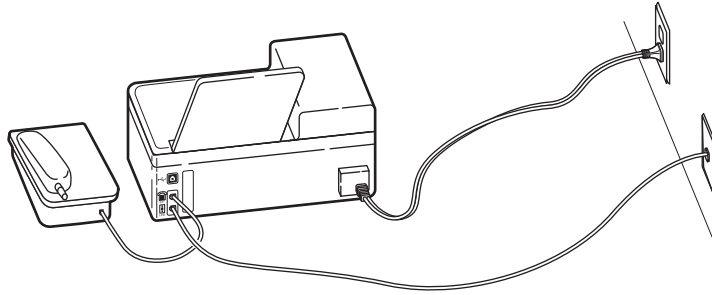

## Scenario 5: Country-specific setup

Different countries have different types of telephone wall jacks. The most common wall jack is the Registered Jack-11 (RJ-11), the standard adopted by most countries. You need to have an RJ-11 plug, or a telephone cable that has an RJ-11 connector, so you can connect a device to an RJ-11 wall jack.

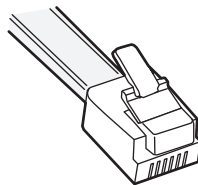

The fax ports on the back of the printer and the telephone cable that comes with the printer have RJ-11 connectors. If you have a different type of connector in your country or region, then you may need to use an RJ-11 adapter.

## Connecting the printer to a non-RJ-11 wall jack

To set up the printer for faxing, connect the printer to the RJ-11 adapter that comes with the printer, and then plug the adapter into the wall jack. You can also connect an additional device (telephone or answering machine) to the same telephone line. If the additional device does not have an RJ-11 connector, then connect it directly to the wall jack. Do *not* remove the wrap plug from the ☎ port of the printer.

**Note:** The printer may not come with an RJ-11 adapter in your country or region.

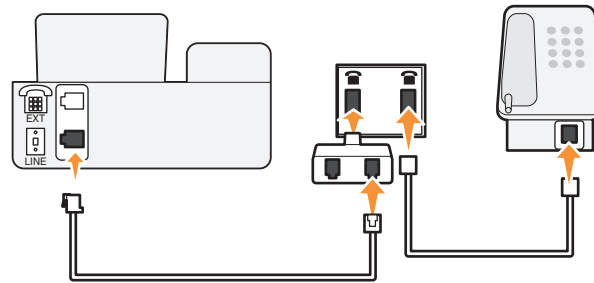
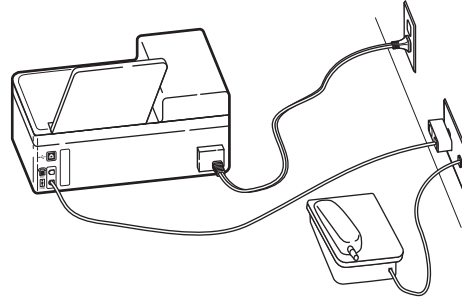



If the additional device (telephone or answering machine) has an RJ-11 connector, then you can remove the wrap plug and plug the device into the ☎ port of the printer.

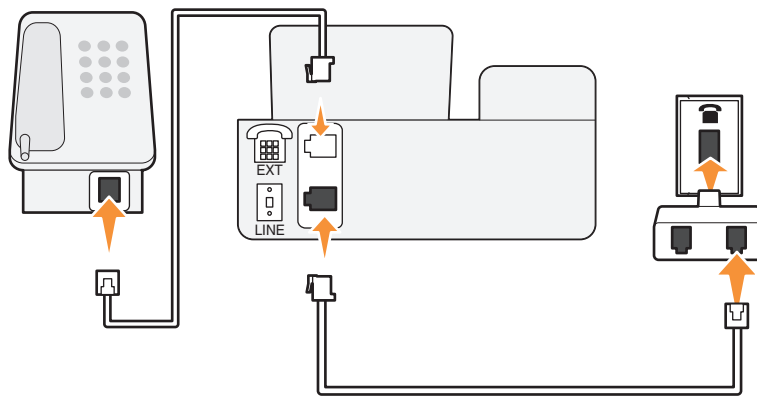
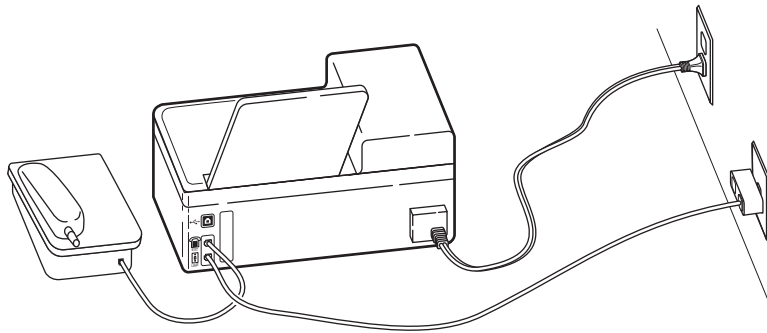

## Connecting the printer in countries that use serial connection

In some countries or regions, you need to plug all devices into the wall jack. You cannot plug a telephone or answering machine into the ☎ port of the printer. This is called serial connection.

Austria	Germany	Portugal
Belgium	Ireland	Spain
Denmark	Italy	Sweden
France	Netherlands	Switzerland
Finland	Norway	United Kingdom

**Warning—Potential Damage:** If your country is on the list, then do *not* remove the wrap plug from the ☎ port of the printer. It is necessary for the proper functioning of the devices on the telephone line.

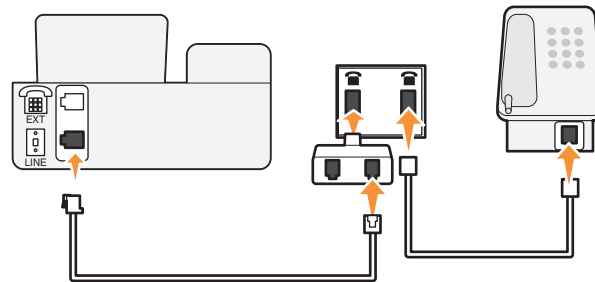
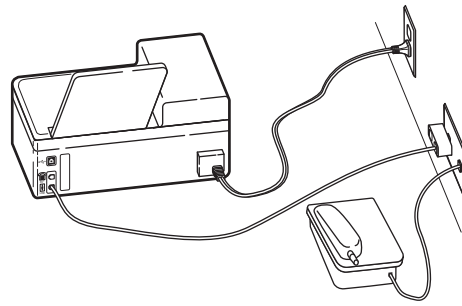

## Connecting the printer to a wall jack in Germany

The German wall jack has two kinds of ports. The N ports are for fax machines, modems, and answering machines. The F port is for telephones.

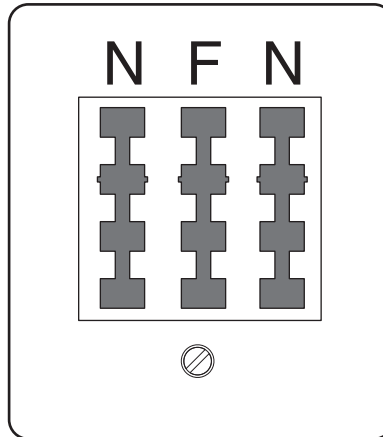

Connect the printer to any of the N ports.

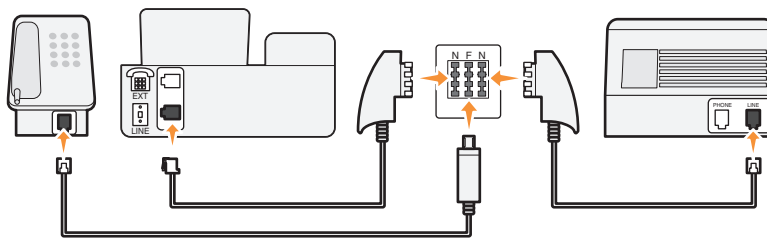
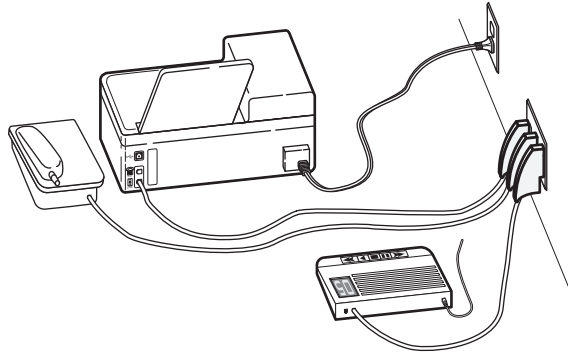

## Entering your user information

Your user information includes your name or your company name, your fax number (your fax number is your telephone number, unless you have a dedicated fax telephone line), and the time and date on your fax machine when a transmission is made. This information appears in the header and footer of the faxes that you send.

In some countries, you cannot send a fax without this information. Some fax machines also block faxes without sender information, so make sure that you enter this information in your printer.

## Setting the fax header

- 1 From the printer control panel, press .
- 2 Press the arrow buttons to scroll to **Fax Setup**, and then press **OK**.
- 3 Press the arrow buttons to scroll to **Dialing and Sending**, and then press **OK**.
- 4 Press **OK** again to select **Your Fax Name**.
- 5 Use the keypad to enter your name or your company name, and then press **OK**.
- 6 Press the arrow buttons to scroll to **Your Fax Number**, and then press **OK**.
- 7 Use the keypad to enter your fax number or your telephone number, and then press **OK**.

## Setting the fax footer

- 1 Press .
- 2 Press the arrow buttons to scroll to **Fax Printing**, and then press **OK**.
- 3 Press the arrow buttons to scroll to **Fax Footer**, and then press **OK**.

- 4 Press **OK** again to select **On**.
- 5 During the initial setup of your printer, you were prompted to enter the date and time. If you have not entered this information, then do the following:
  - a Press  twice.
  - b Press the arrow buttons to scroll to **Device Setup**, and then press **OK**.
  - c Press the arrow buttons to scroll to **Date/Time**, and then press **OK**.
  - d Enter the date using the keypad, and then press **OK**.
  - e Enter the time using the keypad, and then press **OK**.

## Configuring the fax settings

You can configure the fax settings through the printer control panel or the fax software. If you configure the fax settings in the printer control panel, then the fax software imports those settings. The changes appear the next time you launch the fax software. The printer also saves the settings that you choose in the fax software, unless you set the printer to block changes made from the computer.

### Configuring fax settings using the fax software

Before opening the fax software to configure the fax settings, make sure that:

- The printer is properly connected to the telephone line.
- The printer is turned on and connected to the computer.
- The printer is not in Power Saver mode. If the printer is in Power Saver mode, then press  to wake up the printer.

- 1 Click  or **Start**.
- 2 Click **All Programs** or **Programs**, and then select the printer program folder from the list.
- 3 Click **Printer Home**.
- 4 Click the **Fax** tab, and then click **Set up the printer to fax**.  
The Printer Setup Wizard opens.
- 5 Run the Printer Setup Wizard. Make sure you select the correct telephone service and connection. The wizard configures optimal fax settings based on your connection.

**Note:** If you want to configure the advanced fax settings, then click **Configure the advanced settings** in the Fax tab of the Printer Home. This launches the Fax Setup Utility.

For more information, click **Help** or  to view the help information for the fax software.

### Configuring fax settings using the printer control panel

- 1 From the printer control panel, press .
- 2 Press the arrow buttons to scroll to **Fax Setup**, and then press **OK**.

**3** Configure the fax settings using the selections in the menu:

From here	You can
Address Book	Set up, view, or print the Address Book.
Reports	<ul style="list-style-type: none"> <li>• Print activity logs. Activity logs let you view the sent and received fax history of your printer.</li> <li>• Print confirmation pages or transmission reports. These reports let you know if the faxes that you send are sent successfully.</li> </ul>
Ringing and Answering	<ul style="list-style-type: none"> <li>• Set the printer to receive faxes automatically or manually. Turn Auto Answer to On or Off.</li> <li>• Adjust the ringing volume.</li> <li>• Set the number of rings. This is important if you choose to receive faxes automatically (Auto Answer On).</li> <li>• Set the distinctive ring. If you subscribe to the distinctive ring feature on your telephone line, then set the correct pattern for the printer in this menu.</li> <li>• Enable fax forwarding.</li> <li>• Set a manual answer code. This is the code you press to receive faxes manually.</li> <li>• Set the Caller ID pattern that you want. Some countries or regions have multiple patterns.</li> </ul>
Fax Printing	<ul style="list-style-type: none"> <li>• Set the printer to print incoming faxes to fit a page.</li> <li>• Set the fax footer.</li> </ul>
Dialing and Sending	<ul style="list-style-type: none"> <li>• Set your fax name and fax number.</li> <li>• Adjust the dialing volume.</li> <li>• Set the dial method, redial time, number of redial attempts, dialing prefix, and fax sending speed.</li> <li>• Convert sent faxes into modes that receiving fax machines recognize. Otherwise, such faxes are aborted.</li> <li>• Enable error correction during transmission.</li> <li>• Set whether the printer scans the original document before or after dialing the recipient.</li> </ul> <p>Set the printer to scan before dialing so that you do not have to scan the document again if the fax fails. The scanned document is saved in the printer memory. The printer can then retrieve it and automatically redial the number.</p> <p>If you set the printer to scan after dialing, then the printer does not automatically redial, even when the phone line is busy.</p>
Fax Blocking	Block unwanted incoming faxes.

# Creating a contact list

You can create a contact list using the Address Book in the printer control panel or the phone book in the fax software. If you create a contact list in the printer control panel, then the fax software automatically saves those contacts as Speed Dial entries. Likewise, when you add contacts to the Speed Dial list of the fax software, the printer automatically saves them to the printer Address Book.

You can save up to 89 contacts and 10 fax groups in the contact list.

## Creating a contact list using the fax software

- 1 Click  or **Start**.
- 2 Click **All Programs** or **Programs**, and then select the printer program folder from the list.
- 3 Click **Printer Home**.
- 4 Click the **Fax** tab, and then click **Edit contact list**.  
The Contacts tab of the Printer Setup Utility opens.
- 5 Click **Select from phonebook**.
- 6 From the Phonebook field, choose a phone book.
- 7 Select the contact that you want to add, and then click **Add to or change list** to import the contact.

**Note:** To add contacts, you need to import contacts from the phone books on your computer that are supported by the fax software. In addition to the software Address Book, you may also have phone books of the mail clients installed on your computer, such as Microsoft Outlook.

- 8 Click **OK**.

For more information, click **Help** or  to view the help information for the fax software.

## Creating a contact list using the printer control panel

- 1 From the printer control panel, press .
- 2 Press the arrow buttons to scroll to **Fax Setup**, and then press **OK**.
- 3 Press **OK** again to select **Address Book**.
- 4 To add a fax number to your Address Book:
  - a Press the arrow buttons to scroll to **Add**.
  - b Press **OK**.
  - c Press **OK** again to select the Speed Dial number.

**Note:** Numbers 1 to 89 are for individual contacts. Numbers 90 to 99 are for group contacts. When you send a fax, you can enter the Speed Dial number instead of the fax number of your contact.

- d Use the keypad to enter the fax number in the Enter Number field, and then press **OK**.
- e Use the keypad to enter the contact name in the Enter Name field, and then press **OK** to save the entry.
- f Repeat steps 4b through 4e to add additional entries as needed. You can enter up to 89 fax numbers.

- 5 To add a fax group:
- Press **OK** to select **Add**.
  - Using the keypad, enter any number from 90 to 99, and then press **OK**.
  - Enter a fax number in the Enter Number field, and then press **OK**.
  - If you want to add another contact to the group, press the arrow buttons to scroll to **Yes**, and then press **OK**.
  - Repeat step 5d as necessary. You can enter up to 30 fax numbers for the group. If you do not want to add another fax number, then press **OK** to select **No**.
  - Enter the group name in the Enter Name field, and then press **OK** to save the entry.

## Sending faxes

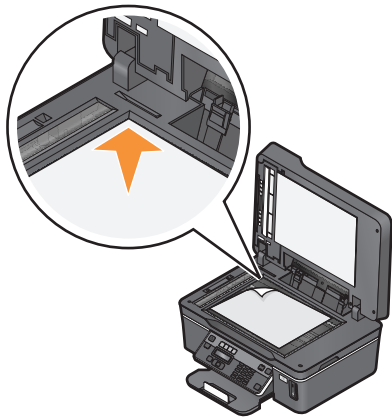
ADF	Scanner glass
 <p>Use the ADF for multiple-page documents.</p> <p><b>Note:</b> The ADF is available only on selected models. If you purchased a printer without an ADF, load original documents or photos on the scanner glass.</p>	 <p>Use the scanner glass for single pages, small items (such as postcards or photos), transparencies, photo paper, or thin media (such as magazine clippings).</p>

## Tips for sending faxes

Before you send a fax:

- Make sure that the printer is on and connected to a working telephone, DSL, or VoIP line. The line is working if you hear a dial tone.
- Load an original document faceup into the ADF or facedown on the scanner glass.
- When using the ADF, adjust the paper guide on the ADF to the width of the original document.
- When using the scanner glass, close the top cover to avoid dark edges on the scanned image.

## Sending faxes using the printer control panel



- 1 From the printer control panel, press .
- 2 Enter a fax number, or press **Address Book** to select a number from the Speed Dial or Group Dial list.

**3** If you want to send a fax to a single recipient, then press **OK**.

If you want to send a fax to a group of numbers (broadcast fax), press the arrow buttons to scroll to **Yes**, and then press **OK**.

**4** Press the **Color/Black** button to select a color or black-and-white fax.

**5** Press  to start the fax job.

**Warning—Potential Damage:** Do not touch the cables or the  and  ports while actively sending a fax.

### Tip:

- You can send a broadcast fax to up to 30 recipients.

## Sending faxes using the computer

**1** With a document open, click **File → Print**.

**2** From the Printer Name menu, select the fax version of your printer, and then click **OK**.  
The Send Fax Wizard appears.

**3** Follow the instructions on the computer screen.

## Receiving faxes

### Tips for receiving faxes

When receiving faxes:

- Make sure that the printer is on and connected to a working telephone, DSL, or VoIP line. The line is working if you hear a dial tone.
- If you set the printer to receive faxes manually (Auto Answer Off), then make sure that the ringer volume is not set to Off.
- If you have set the printer to receive faxes automatically (Auto Answer On), then load paper in the printer.

### Receiving faxes automatically

**1** Make sure that Auto Answer is on:

**a** From the printer control panel, press .

**b** Press the arrow buttons to scroll to **Fax Setup**, and then press **OK**.

**c** Press the arrow buttons to scroll to **Ring and Answering**, and then press **OK**.

**d** Press **OK** again to select **Auto Answer**.

**e** If Auto Answer is not set to On, press the arrow buttons to scroll to **On**, and then press **OK** to save the setting.



**2** Set the number of rings before the printer picks up incoming faxes:

**a** Press the arrow buttons to scroll to **Pick Up On**, and then press **OK**.

**b** Press the arrow buttons to scroll to the number of rings that you want, and then press **OK** to save the setting.





When the number of rings you set is detected, the printer automatically receives the incoming fax.

**Warning—Potential Damage:** Do not touch the cables or the  and  ports while actively receiving a fax.

### Tips:



- If the printer is sharing the line with other analog devices (telephone, answering machine), then set the printer to pick up calls two rings after the answering machine. For example, if the answering machine picks up calls after four rings, then set the printer to pick up after six rings. This way, the answering machine picks up calls first and your voice calls are received. If the call is a fax, then the printer detects the fax signal on the line and takes over the call. If the printer is on a dedicated fax line, then you may set the printer to pick up on any number of rings.
- If you have multiple numbers on a single line, or if you subscribe to a distinctive ring service provided by your telephone company, then make sure that you set the correct ring pattern for the printer. Otherwise, the printer will not receive faxes even if you have set it to receive faxes automatically.

## Receiving a fax manually

- 1 Turn off Auto Answer:
  - a From the printer control panel, press .
  - b Press the arrow buttons to scroll to **Fax Setup**, and then press **OK**.
  - c Press the arrow buttons to scroll to **Ringing and Answering**, and then press **OK**.
  - d Press **OK** again to select **Auto Answer**.
  - e Press the arrow buttons to scroll to **Off**, and then press **OK**.
- 2 When the telephone rings and you hear fax tones when you pick up the handset, press  on the printer or **\*9\*** on the telephone attached to the printer.

**Warning—Potential Damage:** Do not touch the cables or the  and  ports while actively receiving a fax.

### Tips:

- The default code for answering faxes manually is **\*9\***, but for increased security, you can change it to a number that only you know. You can enter up to 7 characters for your code. The valid characters are the digits 0-9 and the characters # and \*.
- Make sure that the telephone is plugged into the  port on the back of the printer and that the printer is connected to the wall jack through the  port.

## Faxing FAQ

### If I skipped the fax setup initially, do I need to run the installer again to set up the fax?

You do not need to run the installer again. You can set up and configure the fax through the fax software that was installed with the printer software.

To set up the fax:

- 1** Connect the printer to the telephone line. For more information, see “Setting up the printer to fax” on page 57.
- 2** Configure the fax settings using the fax software. To access the fax software:
  - a** Click  or **Start**.
  - b** Click **All Programs** or **Programs**, and then select the printer program folder from the list.
  - c** Click **Printer Home**.  
The Printer Home opens.
  - d** Click the **Fax** tab, and then click **Set up the printer to fax**.  
The Printer Setup Wizard opens.
  - e** Run the Printer Setup Wizard. Make sure you select the correct telephone service and connection. The wizard configures optimal fax settings based on your connection.

## What is a splitter and what type of splitter should I use?

If there are limited wall jacks in your home or limited ports on your adapter, then you can use a phone splitter. A splitter splits the telephone signal and allows you to connect multiple devices to the wall jack. It has two or more ports where you can plug the devices. Do *not* use a line splitter.

To make sure that you are using the correct splitter, plug an analog telephone into the splitter and then listen for a dial tone.

## What is my fax number?

In most cases, your telephone number is also your fax number. If you subscribe to the Distinctive Ring Pattern Detection (DRPD) service offered by telephone companies, then your fax number is the number that you assigned to the printer. Make sure that you enter the correct distinctive ring pattern for that number in the fax software or in the Fax Setup menu of the printer control panel.

If you have more than one telephone line, then make sure that you enter the number for the line on which the printer is connected.

## What is my dialing prefix?

The dialing prefix is the number or series of numbers that you press before you can dial the actual fax number or telephone number. If the printer is an office setting or in a private branch exchange, this can be a specific number that you need to press so you can make a call outside the office. This can also be a country code or an area code that you need to enter if you are sending faxes outside of town. This can be very useful if you frequently send faxes to the same country or area. When you set the dialing prefix in the utility, you do not need to press the number or series of numbers every time you dial the fax number or telephone number. The printer automatically inputs the prefix every time you dial.

You can enter up to 8 characters as your dialing prefix. The valid characters are the numbers 0-9 and the characters # and \*. If you are using the fax software to enter the dial prefix, then you may also include the characters period, comma, star, pound, plus, minus, and parenthesis.

## When do I need to set Auto Answer to On?

Set Auto Answer to On if you want the printer to receive faxes automatically.

If the printer is connected to the same telephone line with an answering machine, then you must set Auto Answer to On so that you can receive both your voice calls and your faxes. Make sure that the answering machine is set to pick up on fewer rings than the rings set in the printer. This lets the other devices pick up the voice calls first. If an incoming call is a fax, the printer can detect fax signals on the line and takes the call.

## How many rings should I set?

If the printer is sharing a line with an answering machine, then set the printer to pick up on the greater number of rings. Because you have only one line, there is no way of distinguishing a voice call from an incoming fax. You can set the number of rings so that the answering machine takes the voice calls and the printer takes the incoming faxes. If you set the other devices to pick up on fewer rings, then the devices pick up calls first, and your voice calls are received. If a call is a fax, then the printer can detect it and will take over the call.

If the printer is on a dedicated fax line, then you may set the printer to pick up on any number of rings that you want.

## How do I set the distinctive ring for the printer?

Setting the correct ring is important if you subscribe to the Distinctive Ring Pattern Detection (DRPD) feature offered by telephone companies. This feature allows you to have multiple telephone numbers on one telephone line. Each telephone number has a designated ring pattern (a single ring, a double ring, a triple ring). The different ring patterns let you know what telephone number was dialed, and what device you should use to answer the call.

Assign one of your telephone numbers to the printer as the fax number, and then set the printer to answer the ring pattern of that number. If the pattern is set incorrectly, then the printer rings, but it never receives the fax.

To set the ring pattern in the printer:

- 1 From the printer control panel, press .
- 2 Press the arrow buttons to scroll to **Fax Setup**, and then press **OK**.
- 3 Press the arrow buttons to scroll to **Ring and Answering**, and then press **OK**.
- 4 Press the arrow buttons to scroll to **Ring Pattern**, and then press **OK**.
- 5 Press the arrow buttons to select the ring pattern for the printer, and then press **OK**.

Distinctive Ring is also called Ident-a-Call, Smart Ring, Teen Ring, RingMaster, and Identaring.

## How can I check the dial tone?

A dial tone lets you know if the telephone line is working or if the printer is properly connected to the telephone line. If you encounter problems sending and receiving faxes, then make sure you can hear a dial tone on the line and through the printer.



## Make sure the telephone line and the wall jack are working

- 1 Plug an analog telephone into the wall jack.
- 2 Listen for a dial tone through the telephone handset.

If you hear a dial tone, then the telephone line and the wall jack are working.

If you do not hear a dial tone, plug the analog telephone into a second wall jack, and then listen for a dial tone. If you hear a dial tone, then the telephone line is working but the first wall jack is not working.

## Make sure the printer is connected properly to the telephone line

- 1 While the printer is connected to a telephone line through the  port on the back of the printer, plug an analog telephone into the  port of the printer.
- 2 Listen for a dial tone.

If you hear a dial tone, then the telephone line is working and properly connected to the printer.

If you do not hear a dial tone through both the wall jack and the printer, then see the “Fax troubleshooting checklist” on page 112.

## How do I adjust the speaker volume on the printer?

Listen to the dial tone to check if the telephone line is working and to check if the cables and devices are connected properly in your telephone network. Make sure that the dialing volume is not set to Off, especially if you are dialing a number on hook. If you set the printer to receive faxes manually, then make sure that you set the ringer volume loud enough for you to hear it.

### Adjusting the dialing volume

- 1 From the printer control panel, press .
- 2 Press the arrow buttons to scroll to **Fax Setup**, and then press **OK**.
- 3 Press the arrow buttons to scroll to **Dialing and Sending**, and then press **OK**.
- 4 Press the arrow buttons to scroll to **Dial Volume**, and then press **OK**.
- 5 Press the arrow buttons to select a dial volume setting, and then press **OK**.

### Adjusting the ringer volume

- 1 Press  to scroll back to the Fax Setup menu, and then press **OK**.
- 2 Press the arrow buttons to scroll to **Ring and Answering**, and then press **OK**.
- 3 Press the arrow buttons to scroll to **Ringer Volume**, and then press **OK**.
- 4 Press the arrow buttons to select a ringer volume setting, and then press **OK**.

## How can I make sure that the fax answers the call before the answering machine?

To make sure the printer picks up incoming faxes, set Auto Answer to On, and then set the printer to pick up after a greater number of rings than the answering machine. For example, if the answering machine picks up calls after four rings, then set the printer to pick up after five rings. This way, the answering machine picks up calls first and your voice calls are received. If the call is a fax, then the printer detects the fax signal on the line and takes over the call.

## What settings work best with digital voice mail?

Voice mail and fax can share the same telephone line if you subscribe to a distinctive ring service. This feature allows you to have multiple telephone numbers on one telephone line. Each telephone number has a designated ring pattern (a single ring, a double ring, a triple ring). The different ring patterns let you know which telephone number was dialed, and which device you should use to answer the call.

If you do not have distinctive ring service, then set the printer to receive faxes manually (Auto Answer Off). This setting lets you receive both voice calls and fax calls, but works best if you use voice mail more often. You need to turn off voice mail whenever you are expecting a fax.

## How do I change the resolution of the documents that I fax?



The resolution, or fax quality, of the documents that you send may affect fax transmission. The receiving fax machine may not support high resolutions and may not be able to receive your fax. You can fix this by enabling Auto Fax Conversion, but the automatic conversion may result in an unreadable fax, especially if the original document is already blurred.

Choose a fax quality that best suits the capacity of the receiving fax machine and the quality of the original document.

Quality	Black resolution	Color resolution
Standard	200 x 100	200 x 200
Fine	200 x 200	200 x 200
Superfine	300 x 300	200 x 200
Ultrafine	300 x 300 (half-toned)	200 x 200

When sending a fax, after entering the fax number, press the arrow buttons to select a fax quality, and then press **OK**.

## How do I send a fax at a scheduled time?

- 1 From the printer control panel, press .
- 2 Enter the fax number of the recipient, or press **Address Book** to select a number from the Speed Dial or Group Dial list.
- 3 If you want to send the fax to a single recipient, then press **OK**.  
If you want to send a fax to a group of numbers (broadcast fax), then press the arrow buttons to scroll to **Yes**, and then press **OK**.
- 4 Press **OK** to scroll to **Schedule Fax**.
- 5 Press the arrow buttons to scroll to **Send Later**, and then press **OK**.
- 6 Enter the time you want to send the fax, and then press **OK**.
- 7 Press  to start scanning the document.
- 8 If the printer is not set to the 24-hour mode, press the arrow buttons to select **AM** or **PM**, and then press **OK**.
- 9 Press  to save the scheduled fax.

The printer sends the fax at the designated time. Do *not* turn off the printer or unplug it from the telephone line before the scheduled time.

## How do I send a fax using a phone calling card?

- 1 Press **Dialtone**.  
You should hear the dial tone of the telephone line.
- 2 Enter the calling card information, and then when you are connected to the telephone carrier, follow the prompts.

- 3 When prompted, enter the fax number of the recipient, and then press .

## How do I know that the fax was sent successfully?

You can set the printer to print a confirmation page, or transmission report, every time you send a fax. This report includes the date and time that the fax was sent. If the fax job is unsuccessful, then the report also includes the cause of the error.

- 1 From the printer control panel, press .
- 2 Press the arrow buttons to scroll to **Fax Setup**, and then press **OK**.
- 3 Press the arrow buttons to scroll to **Reports**, and then press **OK**.
- 4 Press the arrow buttons to scroll to **Confirmation**, and then press **OK**.
- 5 Press the arrow buttons to select a report printing option:
  - If you want to print a report every time you send a fax, then select **For All** or **Print for All**.
  - If you want to save on ink and print a report only when a fax job is unsuccessful, then select **On Error**.
- 6 Press **OK**.

## How do I view the fax history of the printer?

You can print reports of sent and/or received faxes.

- 1 From the printer control panel, press .
- 2 Press the arrow buttons to scroll to **Fax Setup**, and then press **OK**.
- 3 Press the arrow buttons to scroll to **Reports**, and then press **OK**.
- 4 Press **OK** again.
- 5 To set when to print fax activity reports, press the arrow buttons to choose whether to print the fax activity reports after 40 faxes or on request only.
- 6 To print fax activity reports, press the arrow buttons to scroll to **Print Reports**, and then press **OK**.
  - To print sent and received fax history, press the arrow buttons to scroll to **Activity Report**, and then press **OK**.
  - To print sent fax history only, press the arrow buttons to scroll to **Send Log**, and then press **OK**.
  - To print received fax history only, press the arrow buttons to scroll to **Receive Log**, and then press **OK**.

## How do I forward a fax?

- 1 From the printer control panel, press .
- 2 Press the arrow buttons to scroll to **Fax Setup**, and then press **OK**.
- 3 Press the arrow buttons to scroll to **Ringing and Answering**, and then press **OK**.
- 4 Press the arrow buttons to scroll to **Fax Forward**, and then press **OK**.
- 5 Press the arrow buttons to scroll to **Forward** or **Print & Forward**, and then press **OK**.
- 6 Using the keypad, enter the number to which you want to forward the fax, and then press **OK**.

When you enable this option, all the faxes that you receive are automatically forwarded until you disable it.

To disable fax forwarding, return to the Fax Forward menu, and then select **Off**.

## Can I block faxes?

You can block faxes from specific numbers. You can also block junk faxes and faxes from unidentified senders (senders without a Caller ID). This feature is helpful if you want to receive faxes automatically but want to filter the faxes that you receive.

- 1** Turn on fax blocking.
  - a** From the printer control panel, press .
  - b** Press the arrow buttons to scroll to **Fax Setup**, and then press **OK**.
  - c** Press the arrow buttons to scroll to **Fax Blocking**, and then press **OK**.
  - d** Press the arrow buttons to scroll to **Turn On/Off**, and then press **OK**.
  - e** Press the arrow buttons to scroll to **On**, and then press **OK** to save the setting.
- 2** Add a number to block.
  - a** Press the arrow buttons to scroll to **Add**.
  - b** Press **OK**.
  - c** Use the keypad to enter the fax number, and then press **OK** to save.
  - d** Use the keypad to enter the name of the person that you want to block.
  - e** Repeat steps 2b through 2d until you have added all the numbers that you want to block. You can block up to 50 numbers.
- 3** Block unidentified faxes (faxes without a Caller ID number).
  - a** Press the arrow buttons to scroll to **Block No-ID**, and then press **OK**.
  - b** Press the arrow buttons to scroll to **On**, and then press **OK** to save the setting.

## Can I retrieve failed faxes?

The printer saves an incoming fax to the printer memory before it prints the fax. If the printer runs out of ink or runs out of paper, then you can print the fax later after resolving the error. The printer prompts you if there are faxes to be printed.

If an incoming fax or an outgoing fax fails due to power loss, then the printer automatically prints an error report the next time it is turned on. For incoming faxes, the error report lets you know who sent the fax and how many pages were not printed. For outgoing faxes, it lets you know how many pages were not sent. Faxes lost due to power loss are not retrievable.

# Networking

## Installing the printer on a wireless network

### Wireless network compatibility

Your printer contains an IEEE 802.11g wireless print server. Your printer is compatible with IEEE 802.11 b/g/n routers that are Wi-Fi certified. If you are having issues with an n router, verify with your router manufacturer that the current mode setting is compatible with g devices, as this setting varies depending on the router brand/model.

### Supported network security options

The printer supports three wireless security options: no security, WEP, and WPA/WPA2.

#### No Security

It is not recommended to use no security at all on a home wireless network. Using no security means that anyone within range of your wireless network can use your network resources—including Internet access, if your wireless network is connected to the Internet. The range of your wireless network may extend far beyond the walls of your home, allowing access to your network from the street or from your neighbors' homes.

#### WEP

WEP (Wireless Equivalent Privacy) is the most basic and the weakest type of wireless security. WEP security relies on a series of characters called the WEP key.

Every device on the wireless network must use the same WEP key. WEP security can be used on both ad hoc and infrastructure networks.

A valid WEP key has:

- Exactly 10 or 26 hexadecimal characters. Hexadecimal characters are A–F, a–f, and 0–9
- or*
- Exactly 5 or 13 ASCII characters. ASCII characters are letters, numbers, punctuation, and symbols found on a keyboard.

#### WPA/WPA2

WPA (Wi-Fi Protected Access) and WPA2 (Wi-Fi Protected Access 2) offer stronger wireless network security than WEP. WPA and WPA2 are similar types of security. WPA2 uses a more complex encryption method and is more secure than WPA. Both WPA and WPA2 use a series of characters, called the WPA pre-shared key or passphrase, to protect wireless networks from unauthorized access.

A valid WPA passphrase has:

- From 8 to 63 ASCII characters. ASCII characters in a WPA passphrase are case-sensitive.
- or*
- Exactly 64 hexadecimal characters. Hexadecimal characters are A–F, a–f, and 0–9.





Every device on the wireless network must use the same WPA passphrase. WPA security is an option only on infrastructure networks with wireless access points and network cards that support WPA. Most newer wireless network equipment also offers WPA2 security as an option.

**Note:** If your network uses WPA or WPA2 security, then select **WPA Personal** when you are prompted to select the type of security your network uses.

## Printing a network setup page

A *network setup page* lists the configuration settings of the printer, including the IP address and MAC address of the printer.

- 1 Load plain paper.
- 2 From the printer control panel, press .
- 3 Press the arrow buttons to scroll to **Network Setup**, and then press .  
**Print Network Setup Page** appears.
- 4 Press  to print the network setup page.

## Information you will need to set up the printer on a wireless network

To set up the printer for wireless printing, you need to know:

- The name of your wireless network. This is also known as the *Service Set Identifier (SSID)*.
- If encryption was used to secure your network.
- The security key (either a WEP key or WPA passphrase) that allows other devices to communicate on the network if encryption was used to secure your network.

You can locate your network WEP key or WPA passphrase by accessing your wireless access point or router and checking the security information.

If your wireless access point (wireless router) is using *Wired Equivalent Privacy (WEP)* security, the WEP key should be:

- Exactly 10 or 26 hexadecimal characters. Hexadecimal characters are A–F, a–f, and 0–9.  
*or*
- Exactly 5 or 13 ASCII characters. ASCII characters are letters, numbers, punctuation, and symbols found on a keyboard.

If your wireless access point is using *Wi-Fi Protected Access (WPA)* security, the WPA passphrase should be:

- From 8 to 63 ASCII characters. ASCII characters in a WPA passphrase are case-sensitive.  
*or*
- Exactly 64 hexadecimal characters. Hexadecimal characters are A–F, a–f, and 0–9.

If your wireless network is not using security, then you will not have a security key.

**Note:** If you do not know the SSID of the network that your computer is connected to, launch the wireless utility of the computer network adapter and look for the network name. If you cannot find the SSID or the security information for your network, see the documentation that came with the wireless access point, or contact your system support person.

## Installing the printer on a wireless network

Before you install the printer on a wireless network, make sure that:

- Your wireless network is set up and working properly.
- The computer you are using is connected to the same wireless network where you want to set up the printer.

**1** Close all open software programs.

**2** Insert the installation software CD.

If the Welcome screen does not appear after a minute, then launch the CD manually:

- a** Click , or click **Start** and then click **Run**.
- b** In the Start Search or Run box, type `D:\setup.exe`, where **D** is the letter of your CD or DVD drive.

**3** Follow the instructions on the Welcome screen to set up the printer.

## Installing the printer on other computers

Once the printer is set up on the wireless network, it can be accessed wirelessly by any other computer on the network. However, you will need to install the printer driver on every computer that will access it. You do not need to configure the printer again, although you will need to run the setup software on each computer to install the driver.

**1** Close all open software programs.

**2** Insert the installation software CD.

If the Welcome screen does not appear after a minute, then launch the CD manually:

- a** Click , or click **Start** and then click **Run**.
- b** In the Start Search or Run box, type `D:\setup.exe`, where **D** is the letter of your CD or DVD drive.

**3** Follow the instructions on the computer screen for installing a configured printer on a new computer.

## Interpreting the colors of the Wi-Fi indicator light

The colors of the Wi-Fi indicator light show the network status of the printer.

- **Off** means one of the following:
  - The printer is turned off or is powering up.
  - The printer is not connected to a wireless network and is in Power Saver mode. In Power Saver mode, the power light pulses on and off.
- **Solid orange** means one of the following:
  - The printer has not yet been configured for a wireless network.
  - The printer is configured for an ad hoc connection, but it is not currently communicating with another ad hoc device.
- **Blinking orange** means one of the following:
  - The printer is out of the range of the wireless access point (wireless router).
  - The printer is trying to communicate with the wireless access point, but the wireless access point is turned off or not working properly.
  - Either the configured printer or the wireless access point has been turned off and back on, and the printer is trying to establish communications with the network.
  - The wireless settings of the printer may no longer be valid.
- **Green** means that the printer is connected to a wireless network and is ready for use.

## Special wireless installation instructions

The following instructions apply to customers outside of North America who are using a wireless broadband box. Some examples of these boxes include LiveBox, AliceBox, N9UF Box, FreeBox, and Club Internet.

### Before you begin

- Make sure your box is wireless-enabled and activated to work on a wireless network. For more information about configuring the box to work wirelessly, see the documentation that came with your box.
- Make sure your box is turned on and that your computer is on and connected to your wireless network.

### Adding the printer to your wireless network

- 1** Set up your printer for wireless networking using the setup instructions provided.  
Stop when you are prompted to select a network.
- 2** If there is an association/registration button on the back of your box, press it before selecting a network.

**Note:** After pressing the association/registration button, you have five minutes to complete the printer installation.

- 3** Return to the computer screen.

From the list that appears in the “Choose your wireless network” dialog, select your network, and then click **Continue**.

If your wireless network does not appear in the list:

- a** Select **Unlisted Network**, and then click **Continue**.
- b** Enter the details about your wireless network.

**Note:** Your WEP, WPA, or WPA2 key may be obtained from the bottom of the box, the user’s guide that came with the box, or from the box Web page. If you have already changed the key for your wireless network, use the key you created.

- 4** Follow the instructions on your screen to complete installation.

### Assigning a static IP address

The printer will be assigned an IP address automatically through DHCP on most wireless networks.

If you want to assign a static IP address to your printer, do the following:

- 1** Complete the wireless setup, allowing the printer to receive a DHCP address from a DHCP server on the network.
- 2** Print a network setup page to see what IP address is currently assigned to the printer.
- 3** Open a Web browser and then type the printer IP address in the address field. Press **Enter**.  
The printer Web page loads.
- 4** Click the **Configuration** link.
- 5** Click the **TCP/IP** link.
- 6** Click the **Set Static IP Address** link.

7 Type the IP address you want to assign to the printer in the **IP Address** field.

8 Click the **Submit** button.

The Submitting Selection message appears.

To confirm that the address was successfully assigned, type the static IP address in the Web browser address field and then press **Enter**. The printer Web page loads if the address was successfully assigned.

For more information, contact your system support person.

## Changing wireless settings after installation

To change wireless settings on the printer, such as the configured network, the security key, or other settings, do the following:

- 1 Click  or **Start**.
- 2 Click **All Programs** or **Programs**, and then select the printer program folder from the list.
- 3 Select **Printer Home**.
- 4 Click the **Settings** tab.
- 5 Click the **Wireless setup utility** link.
- 6 Follow the instructions on the computer screen to configure the printer for wireless access with the new settings.

## Advanced wireless setup

### Creating an ad hoc wireless network

The recommended way to set up your wireless network is to use a wireless access point (wireless router). A network set up this way is called an *infrastructure network*. If you have an infrastructure network, you should configure the printer for use on that network.

**Note:** The printer can communicate on only one wireless network at a time. Configuring the printer for an ad hoc wireless network will keep it from working on any other wireless network, either ad hoc or infrastructure.

You can set up an ad hoc network if you:

- Do not have an access point or wireless router
- Do not already have a wireless network (but do have a wireless adapter for your computer)
- Want to set up a standalone network between the printer and a computer with a wireless network adapter

### In Windows Vista

- 1 Click .
- 2 Click **Control Panel**.
- 3 Click **Network and Internet**.
- 4 Under Network and Sharing Center, click **Connect to a Network**.
- 5 In the Connect to a Network dialog, click **Set up a wireless ad-hoc (computer-to-computer) network**, and then click **Next**.

- 6 Follow the instructions in the “Set up a wireless ad hoc network” wizard. As part of the setup:
  - a Create a network name or SSID for the network between the computer and your printer.
  - b Write down the name of your network. Be sure to use the exact spelling and capitalization.
  - c Go to the Security Type list, select **WEP**, and then create a WEP key.

WEP keys must be:

- Exactly 10 or 26 hexadecimal characters. Hexadecimal characters are A-F, a-f, and 0-9.  
*or*
  - Exactly 5 or 13 ASCII characters. ASCII characters are letters, numbers, and symbols found on a keyboard
- d Write down the password for your network. Be sure to use the exact spelling and capitalization.

Windows Vista will enable the ad hoc network for you. It will appear in the “Connect to a network” dialog under “Available networks,” indicating that the computer is configured for the ad hoc network.

- 7 Close the Windows Control Panel and any remaining windows.
- 8 Insert the installation software CD, and follow the directions for wireless installation.  
**Note:** Do not connect the installation or network cables until instructed to do so by the setup software.
- 9 When the available networks are displayed, provide the network name and the security information you created in step 6. The installer will configure the printer for use with your computer.
- 10 Store a copy of your network name and security information in a safe place for future reference.

## In Windows XP

- 1 Click **Start**.
- 2 Click **Control Panel**.
- 3 Click **Network and Internet Connections**.
- 4 Click **Network Connections**.
- 5 Right-click the icon for your wireless network connection.
- 6 Click **Enable**, if it appears in the pop-up menu.  
**Note:** If Disable appears, your wireless connection is already enabled.
- 7 Right-click the **Wireless Network Connection** icon.
- 8 Click **Properties**.
- 9 Click the **Wireless Networks** tab.  
**Note:** If the Wireless Networks tab does not appear, your computer has third-party software that controls your wireless settings. You must use that software to set up the ad hoc wireless network. For more information, see the documentation for the third-party software to learn how to create an ad hoc network.
- 10 Select the **Use Windows to configure my wireless network settings** check box.
- 11 Under Preferred Networks, delete any existing networks.
  - a Select the network to be removed.
  - b Click **Remove** to delete the network from the list.
- 12 Click **Add** to create an ad hoc network.

- 13** In the Network Name (SSID) box, type the name you want to give your wireless network.
- 14** Write down the network name you chose so you can refer to it when running the wireless setup. Be sure to use the exact spelling and capitalization.
- 15** If Network Authentication appears in the list, select **Open**.
- 16** In the "Data encryption" list, select **WEP**.
- 17** If necessary, clear the "The key is provided for me automatically" check box.
- 18** In the Network Key box, type in a WEP key.
- 19** Write down the WEP key you chose so you can refer to it when running the wireless setup. Make sure you copy it down exactly, including any capital letters.
- 20** In the "Confirm network key" box, type the same WEP key.
- 21** Select **This is a computer-to-computer (ad hoc) network; wireless access points are not used**.
- 22** Click **OK** twice to close the two open windows.
- 23** It may take a few minutes for your computer to recognize the new settings. To check on the status of your network:
  - a** Right-click the **Wireless Network Connections** icon.
  - b** Select **View Available Wireless Networks**.
    - If the network is listed but the computer is not connected, select the ad hoc network and then click **Connect**.
    - If the network does not appear, wait a minute and then click **Refresh network list**.
- 24** Insert the installation software CD, and follow the directions for wireless installation.

**Note:** Do not connect the installation or network cables until instructed to do so by the setup software.
- 25** When the available networks are displayed, provide the network name and the security information you created beginning in step 13. The installer will configure the printer for use with your computer.
- 26** Store a copy of your network name and security information in a safe place for future reference.

## In Windows 2000

- Refer to the documentation that came with your wireless network adapter for information on configuring an ad hoc network with Windows 2000.

## Adding a printer to an existing ad hoc wireless network

**Note:** The printer can communicate on only one wireless network at a time. Configuring the printer for an ad hoc wireless network will remove it from any other wireless network, either ad hoc or infrastructure, for which it is configured.

- 1** Click  or **Start**.
- 2** Click **All Programs** or **Programs**, and then select the printer program folder from the list.
- 3** Select **Printer Home**.
- 4** Click the **Settings** tab.
- 5** Click **Wireless setup utility** link.
- 6** Follow the instructions on the computer screen.

## Configuring the printer wirelessly using WPS (Wi-Fi Protected Setup)

*Wi-Fi Protected Setup (WPS)* is a method of configuring computers and printers on a secure wireless network. WPS is faster and eliminates typing errors when new devices are added to a wireless network. The SSID and WPA passphrase are automatically detected and configured for you. The printer supports WPS and can be configured for a wireless access using WPS. In order to use WPS to configure the printer, the wireless router must also support WPS.

If you want to use WPS to set up your printer, then insert the CD and follow the instructions on the computer screen.

**Note:** To use WPS to configure the printer wirelessly, all of the devices on your wireless network must support WPS. If any device on your network does not support WPS, then you must type the SSID and security information when prompted.

## Switching between USB and wireless connections (Windows only)

You can change the way you access your printer, depending on your needs. The following procedures assume that you have configured your printer for one type of connection and that the printer drivers are installed on the computer. See related topics on troubleshooting specific connection types if you encounter difficulties during configuration.

### Using the printer wirelessly

- 1 Click  or **Start**.
- 2 Click **All Programs** or **Programs**, and then select the printer program folder from the list.
- 3 Select **Printer Home**.
- 4 Click the **Settings** tab.
- 5 Click the **Wireless setup utility** link.
- 6 Follow the instructions on the computer screen to set up the printer wirelessly.

**Note:** There is no need to remove the USB cable connecting the printer to the computer during wireless configuration.

### Using the printer locally (USB)

- 1 Attach a USB cable to the computer and to the printer.
- 2 Wait a moment for Windows to locate the driver and finish setting up the printer.

**Note:** You can continue to use the printer wirelessly.

## Sharing a printer in a Windows environment

- 1 Prepare the computers to share the printer:
  - a Make all computers printing to the printer accessible through Network Neighborhood by enabling File and Print Sharing. See the Windows documentation for instructions on enabling File and Print Sharing.
  - b Install the printer software on all computers that will print to the printer.
- 2 Identify the printer:
  - a On the computer that is attached to the printer, do one of the following:
    - 1 Click , or click **Start** and then click **Run**.
    - 2 In the Start Search or Run box, type `control printers`.

**3** Press **Enter**, or click **OK**.

The printer folder opens.

**b** Right-click the name of your printer.

**c** Click **Sharing**.

**d** From the Sharing tab, select **Share this printer** or **Shared as**, and then assign a distinctive name.

**e** Click **OK**.

**3** Locate the printer from the remote computer:

**Note:** The remote computer is the one that is not attached to the printer.

**a** Do one of the following:

**1** Click , or click **Start** and then click **Run**.

**2** In the Start Search or Run box, type `control printers`.

**3** Press **Enter**, or click **OK**.

The printer folder opens.

**b** Right-click the name of your printer.

**c** Click **Properties**.

**d** Click the **Ports** tab, and then click **Add Port**.

**e** Select **Local Port**, and then click **New Port**.

**f** Type the **Universal Naming Convention (UNC) Port name**, which consists of the server name and the distinctive printer name that was specified in step 2 on page 87. The name should be in the form `\\server\printer`.

**g** Click **OK**.

**h** Click **Close** on the Printer Ports dialog.

**i** Make sure the new port is selected on the Ports tab, and then click **Apply**.

The new port is listed with the printer name.

**j** Click **OK**.

## Networking FAQ

### What is Wi-Fi Protected Setup?

Wi-Fi Protected Setup (WPS) is a product certification that provides simple and secure configuration. WPS assists users in establishing wireless home networks and enabling network security without requiring prior knowledge of Wi-Fi technology. WPS configures the network name (SSID) and WPA passphrase for network devices. WPS only supports networks that communicate through access points or routers and is not applicable in ad hoc networks.

We support the following methods in adding new wireless network devices:

- *Personal Identification Number (PIN)*—A PIN from the new device is entered into the access point.
- *Push Button Configuration (PBC)*—The user pushes a button on both the access point and the new device.



Look for any of these identifier marks to check if your device is WPS certified:



You can find these WPS logos on the side, back, or top of your access point or router.

## Where do I find my WEP key or WPA passphrase?

To find the WEP key or WPA passphrase for the wireless network, view the security settings on the access point or wireless router. Most access points have a Web page that can be accessed using a Web browser.

You can also check the manual that came with your access point or router. If your access point or router is using the default settings, you can find the information in the manual. If someone else set up your network for you, that person or company may have included the information in the manual.

If you do not know how to access the Web page, or if you do not have administrator access to the wireless access point on your network, and are unable to locate the information in the manual, contact your system support person.

## What is an SSID?

A Service Set Identifier (SSID) is the name that identifies a wireless network. All devices on the network must know the SSID of the wireless network or they will not be able to communicate with each other. Usually, the wireless network broadcasts the SSID to allow wireless devices in the area to connect to it. Sometimes, the SSID is not broadcast for security reasons.

If the SSID of your wireless network is not broadcast, it cannot be detected automatically and will not show up in the list of available wireless networks. You must enter the network information manually in this situation.

An SSID can contain up to 32 alphanumeric characters.

## Where do I find my SSID?

You can find the SSID for the wireless network by viewing the settings on the access point or wireless router. Most access points have a built-in Web server that can be accessed using a Web browser.

Many network adapters provide a software application that allows you to view the wireless settings of your computer, including your SSID. Check your computer to see if a program was installed with your network adapter.

If you are unable to locate your SSID using either of these methods, contact your system support person.

## What is a network?

A network is a collection of devices such as computers, printers, Ethernet hubs, wireless access points, and routers connected together for communication through cables or through a wireless connection. A network can be wired, wireless, or designed to have both wired and wireless devices.

Devices on a wired network use cables to communicate with each other.

Devices on a wireless network use radio waves instead of cables to communicate with each other. For a device to be able to communicate wirelessly, it must have a wireless network adapter attached or installed that lets it receive and transmit radio waves.

## How do I find out what type of security my network is using?

You must know the WEP key or WPA passphrase and the type of security (WEP, WPA, or WPA2) used on the wireless network. To obtain this information, see the documentation that came with your wireless access point (wireless router), see the Web page associated with the wireless access point, or consult your system support person.

**Note:** The WEP key or WPA passphrase is not the same as the password for the wireless access point. The password allows you to access the wireless access point settings. The WEP key or WPA passphrase allows printers and computers to join your wireless network.

## How are home networks configured?

For desktop computers, laptops, and printers to communicate with each other over a network, they must be connected by cables and/or have wireless network adapters built in or installed in them.

There are many different ways a network can be set up. Four common examples appear below.

**Note:** The printers in the following diagrams represent printers with internal print servers built into them so that they can communicate over a network.

### Wireless network examples

#### Scenario 1: Mixed wired and wireless connections on a network with Internet access

- All computers and printers connect to the network through a router with Ethernet and wireless capabilities.
- Some computers and printers connect wirelessly to the router; others connect over a wired connection.
- The network is connected to the Internet through a DSL or cable modem.

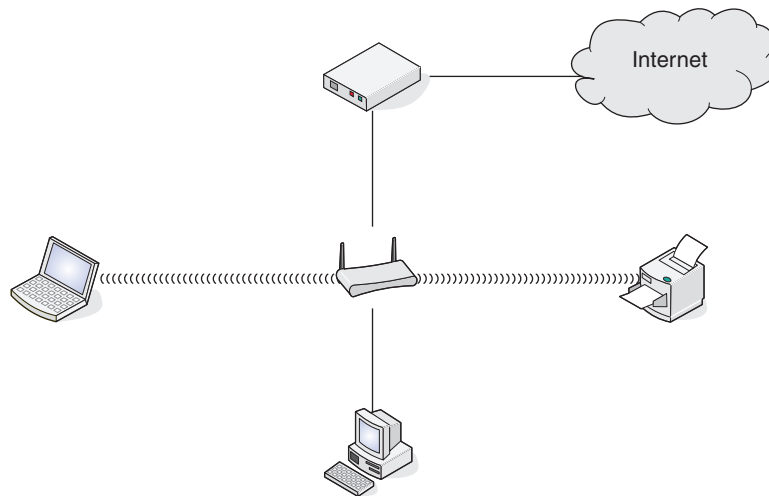

### Scenario 2: Wireless network with Internet access

- All computers and printers connect to the network using a wireless access point or wireless router.
- The wireless access point connects the network to the Internet through a DSL or cable modem.

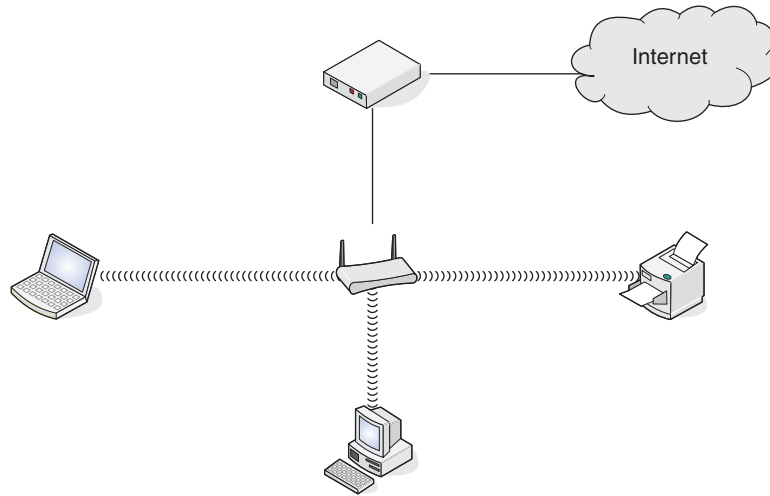

### Scenario 3: Wireless network with no Internet access

- Computers and printers connect to the network using a wireless access point.
- The network has no connection to the Internet.

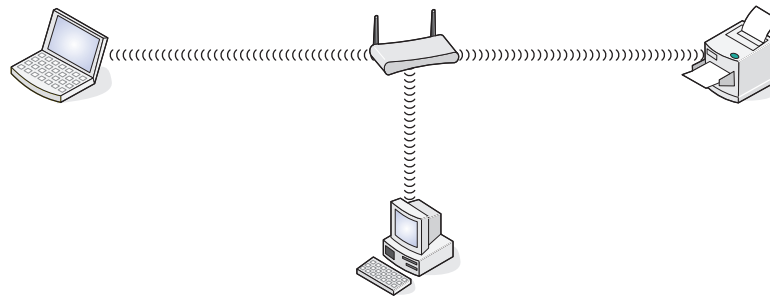

### Scenario 4: Computer connected wirelessly to a printer without Internet access

- A computer is directly connected to a printer without going through a wireless router.
- This configuration is referred to as an *ad hoc network*.
- The network has no connection to the Internet.

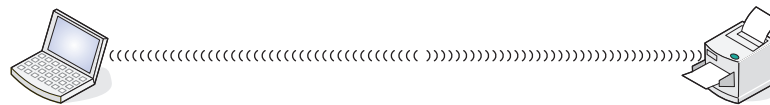

**Note:** Most computers can connect to only one wireless network at a time. If you access the Internet over a wireless connection, you will lose Internet access if you are connected to an ad hoc network.

## Why do I need an installation cable?

When setting up the printer on your wireless network, the printer will need to temporarily connect to a computer using the installation cable. This temporary connection is used to set up the wireless settings of the printer.

The installation cable connects to a rectangular USB port on the installing computer and the square USB port on the printer.

## How do I attach the installation cable?

The installation cable attaches to a USB port on the computer and to the square connector on the back of the printer. This connection allows you to configure the printer for a networked or locally attached installation.

- 1 Attach the large, rectangular connector to any USB port on your computer. USB ports may be on the front or the back of the computer, and may be horizontal or vertical.

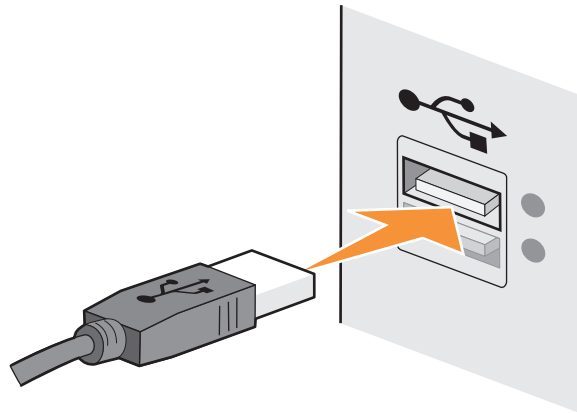

- 2 Attach the small, square connector to the printer.

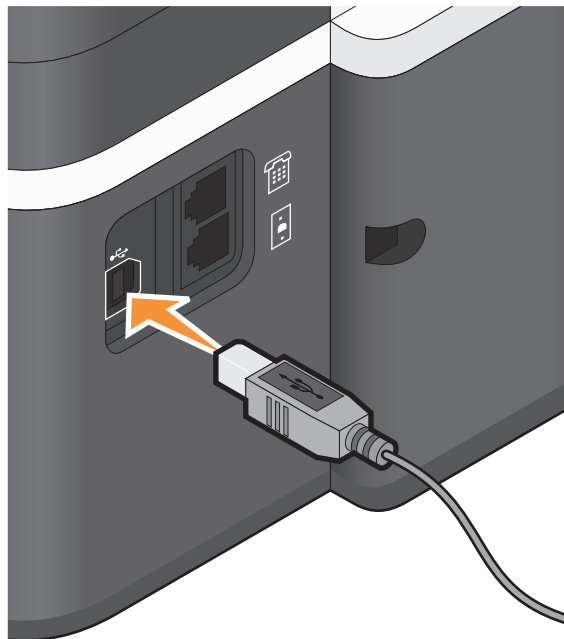

- 3 Continue following the on-screen instructions.

## How are infrastructure and ad hoc networks different?

Wireless networks can operate in one of two modes: infrastructure or ad hoc.

In *infrastructure* mode, all devices on a wireless network communicate with each other through a wireless router (wireless access point). Devices on the wireless network must have valid IP addresses for the current network and share the same SSID and channel as the wireless access point.

In *ad hoc* mode, a computer with a wireless network adapter communicates directly with a printer equipped with a wireless print server. The computer must have a valid IP address for the current network and be set to ad hoc mode. The wireless print server must be configured to use the same SSID and channel that the computer is using.

The following table compares the characteristics and requirements of the two types of wireless networks.

	Infrastructure	Ad hoc
<b>Characteristics</b>		
Communication	Through wireless access point	Directly between devices
Security	More security options	WEP or no security
Range	Determined by range and number of wireless access points	Restricted to range of individual devices on network
Speed	Usually faster	Usually slower
<b>Requirements for all devices</b>		
Unique IP address for each device	Yes	Yes
Mode set to	Infrastructure mode	Ad hoc mode
Same SSID	Yes, including the wireless access point	Yes
Same channel	Yes, including the wireless access point	Yes

We recommend setting up a network in infrastructure mode using the installation CD that came with the printer.

Infrastructure mode is the recommended setup method because it provides:

- Increased network security
- Increased reliability
- Faster performance
- Easier setup

## Finding the signal strength

Wireless devices have built-in antennas that transmit and receive radio signals. The signal strength listed on the printer network setup page indicates how strongly a transmitted signal is being received. Many factors can affect the signal strength. One factor is interference from other wireless devices or other devices such as microwave ovens. Another factor is distance. The farther two wireless devices are from each other, the more likely it is that the communication signal will be weaker.

The strength of the signal received by your computer can also affect the connectivity of the printer with the network during configuration. When you installed the wireless adapter in your computer, the adapter software probably placed an icon in your system tray. Try double-clicking this icon, and it will tell you how strongly the computer is receiving the wireless signal from the network.

To improve signal quality, remove sources of interference and/or move wireless devices closer to the wireless access point (wireless router).

## How can I improve wireless signal strength?

A common reason wireless printers fail to communicate over a network is poor wireless signal quality. If the signal is too weak, too distorted, or blocked by an object, it cannot carry information between the access point and the printer. To determine if the printer is receiving a strong signal from the access point, print a network setup page. The Quality field indicates the relative strength of the wireless signal the printer is receiving. Drops in signal strength can be intermittent, however, and although the signal quality appears high, it may drop during certain conditions.

If you think signal strength is a problem between your access point and the printer, try one or more of the following:

### Notes:

- The solutions below are for infrastructure networks. If you are using an ad hoc network, adjust the computer when the solution suggests adjusting the access point.
- Ad hoc networks have a much shorter range than infrastructure networks. Try moving the printer closer to the computer if they seem to have trouble communicating.

### **MOVE THE PRINTER CLOSER TO THE WIRELESS ACCESS POINT/WIRELESS ROUTER**

If the printer is too far away from the access point, it will not be able to communicate with other devices on the network. For most indoor wireless networks, the maximum distance between the access point and the printer is approximately 100 feet (30 meters). This distance could be longer or shorter, depending upon the layout of the network and the limitations of the access point.

### **REMOVE OBSTACLES BETWEEN THE ACCESS POINT AND THE PRINTER**

The wireless signal from your access point will pass through most objects. Most walls, floors, furniture and other objects will not block the wireless signal. However, there are materials that are too dense for the signal to pass through. Objects containing metal and concrete can block the signal. Arrange your printer and access point so that the signal is not blocked by such objects.

### **REMOVE SOURCES OF INTERFERENCE**

Other types of radio frequencies can cause problems with the wireless signal on your network. These sources of interference can cause printing issues that seem to come and go. Turn off potential sources of interference where possible. Avoid using microwaves and cordless phones when printing over your wireless network.

If another wireless network is operating in the vicinity, change the wireless channel on the access point.

Do not place your access point on a printer or other electronic device. Such devices can also interfere with the wireless signal.

### **ARRANGE THE NETWORK TO REDUCE SIGNAL ABSORPTION**

Even when the wireless signal is able to pass through an object, it is slightly weakened. If it passes through too many objects, it can be significantly weakened. All objects absorb part of the wireless signal when it passes through them, and certain types of objects absorb enough to cause communications problems. Place your access point as high in the room as possible to avoid signal absorption.

## How can I make sure my computer and printer are connected to the same wireless network?

If the printer is not on the same wireless network as the computer, you will not be able to print wirelessly. The SSID of the printer must match the SSID of the computer, if the computer is already connected to the wireless network.

- 1 Obtain the SSID of the network that the computer is connected to:
  - a Type the IP address of your wireless access point (wireless router) into the address field of your Web browser.  
If you do not know the IP address of the wireless access point:
    - 1 Click , or click **Start** and then click **Run**.
    - 2 In the Start Search or Run box, type `cmd`.
    - 3 Press **Enter**, or click **OK**.  
The Command Prompt window opens.
    - 4 Type `ipconfig`, and then press **Enter**. Check the Wireless Network Connection section:
      - The “Default Gateway” entry is typically the wireless access point.
      - The IP address appears as four sets of numbers separated by periods, such as 192.168.2.134.
  - b Type the user name and password of the router when prompted.
  - c Click **OK**.
  - d On the main page, click **Wireless** or any other selection where settings are stored. The SSID will be displayed.
  - e Write down the SSID.

**Note:** Make sure you copy it exactly, including any capital letters.

- 2 Print the printer network setup page.  
In the Wireless section, look for **SSID**.
- 3 Compare the SSID of the computer and SSID of the printer.  
If the SSIDs are the same, then the computer and the printer are connected to the same wireless network.  
If the SSIDs are not the same, then run the utility again to set up the printer on the wireless network used by the computer.

## Can I use my printer on a USB and a network connection at the same time?

Yes, the printer supports a simultaneous USB and network connection. The printer can be configured in the following ways:

- Locally attached (connected to a computer using a USB cable)
- Wireless network
- Wireless network and locally attached simultaneously

## What is a MAC address?

A Media Access Control (MAC) address is a 48-bit identifier associated with the hardware of network equipment. The MAC address may also be called the physical address because it is connected to the hardware of a device instead of its software. The MAC address is displayed as a hexadecimal number in this format: 01-23-45-67-89-AB.

Every device capable of communicating on a network has a MAC address. Network printers, computers, and routers, whether Ethernet or wireless, all have MAC addresses.

While it is possible to change the MAC address of a network device, it is not common practice to do so. For this reason, MAC addresses are considered permanent. IP addresses are easily changed, so MAC addresses are a more reliable method of identifying a specific device on a network.

Routers with security capabilities may allow filtering of MAC addresses on networks. This allows a managed list of devices to access the network, identified by their MAC addresses. MAC address filtering can help prevent access on the network from unwanted devices, such as from intruders on a wireless network. MAC address filtering can also prevent legitimate access if you forget to add a new device to the router's list of allowed addresses. If your network uses MAC address filtering, be sure to add the MAC address of the printer to the list of allowed devices.

## How do I find the MAC address?

Most network equipment has a unique hardware identification number to distinguish it from other devices on the network. This is called the *Media Access Control (MAC)* address.

When installing the printer on a network, make sure you select the printer with the correct MAC address.

The MAC address label is located inside the printer.

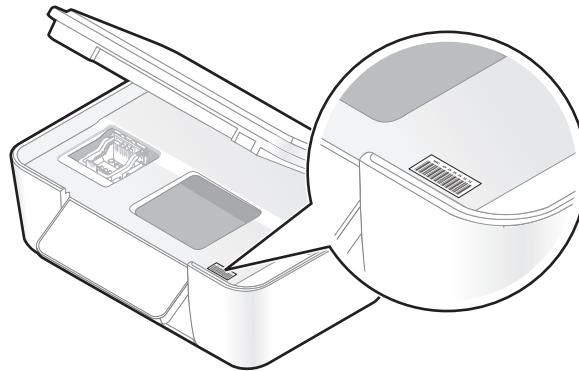

The MAC address of the internal print server is a series of letters and numbers. Other devices sometimes use a type of MAC address called *Universally Administered Address (UAA)*.



**Note:** A list of MAC addresses can be set on an access point (router) so that only devices with matching MAC addresses are allowed to operate on the network. This is called *MAC filtering*. If MAC filtering is enabled in your access point and you want to add a printer to your network, then the MAC address of the printer must be included in the MAC filter list.

## What is an IP address?

An IP address is a unique number used by devices (such as a wireless printer, computer, or wireless access point) on an IP network to locate and communicate with each other. Devices on an IP network can communicate with each other only if they have unique and valid IP addresses. A unique IP address means no two devices on the same network have the same IP address.

An IP address is a group of four numbers separated by periods. An example of an IP address is 192.168.100.110.



## What is TCP/IP?

Networks are able to function because computers, printers, and other devices are able to send data to each other, either through cables or by using wireless signals. This transfer of data is made possible by sets of data transmission rules called *protocols*. A protocol can be thought of as a language, and like a language, it has rules allowing participants to communicate with each other.

Different types of networks use different protocols, but *Transmission Control Protocol/Internet Protocol* (TCP/IP) is the most popular. TCP/IP is used to send data over the Internet as well as over most corporate and home networks.

Because computers do not understand words and instead rely upon numbers for communication, TCP/IP requires that every device on a network using TCP/IP to communicate must have an IP address. IP addresses are essentially unique computer names in a numeric format, used to transfer data around a network. IP addresses allow TCP/IP to confirm requests for and receipt of data by various devices on the network.

## How do I locate IP addresses?

1 Click , or click **Start** and then click **Run**.

2 In the Start Search or Run box, type `cmd`.

3 Press **Enter**, or click **OK**.

The Command Prompt window opens.

4 Type `ipconfig`, and then press **Enter**.

The IP address appears as four sets of numbers separated by periods, such as 192.168.0.100.

## How to locate a printer IP address

- You can locate the printer IP address by viewing the printer network setup page.

## How are IP addresses assigned?

An IP address may be assigned automatically by the network using DHCP. Once the printer is set up on a computer, the computer sends all print jobs across the network to the printer using this address.

If the IP address is not automatically assigned, you will be asked during wireless setup to manually enter an address and other network information after selecting your printer from the available list.

## What is a key index?

A wireless access point (wireless router) can be configured with as many as four WEP keys. Only one key is used on the network at a time, however. The keys are numbered, and the number of a key is referred to as its key index. All devices on the wireless network must be configured to use the same key index when multiple WEP keys are configured on the wireless access point.

Select the same key index on your printer as you are using on your wireless access point.

# Maintaining the printer

## Maintaining ink cartridges

### Checking ink levels

#### Using the printer control panel

- 1 From the printer control panel, press .
- 2 Press the arrow buttons to scroll to **Maintenance**, and then press **OK**.
- 3 Press **OK** again to select **Ink Levels**.
- 4 Press the arrow buttons to check the ink level in each cartridge.

#### Using the printer software

- 1 Click  or **Start**.
- 2 Click **All Programs** or **Programs**, and then select the printer program folder from the list.
- 3 Select **Printer Home**.
- 4 Choose your printer from the printer drop-down list.
- 5 From the Maintenance tab, click **Check ink levels**.

## Aligning the printhead

If the characters or lines on your printer image appear jagged or wavy, then you may need to align the printhead.

#### Using the printer control panel

- 1 Load plain paper.
- 2 From the printer control panel, press .
- 3 Press the arrow buttons to scroll to **Maintenance**, and then press **OK**.
- 4 Press the arrow buttons to scroll to **Align Printer**, and then press **OK**.
- 5 Press **OK** again.

An alignment page prints.

**Note:** Do not remove the alignment page until printing is finished.

#### Using the printer software

- 1 Load plain paper.
- 2 Click  or **Start**.
- 3 Click **All Programs** or **Programs**, and then select the printer program folder from the list.

- 4 Select **Printer Home**.
- 5 Choose your printer from the printer drop-down list.
- 6 From the Maintenance tab, click **Align cartridges**.
- 7 Follow the instructions on the computer screen.

If you aligned the cartridges to improve print quality, then print your document again. If print quality has not improved, then clean the printhead nozzles.

## Cleaning the printhead nozzles

Poor print quality is sometimes due to clogged printhead nozzles. Clean the printhead nozzles to improve the quality of your prints.

### Notes:

- Cleaning the printhead nozzles uses ink, so clean them only when necessary.
- Deep cleaning uses more ink, so try the Clean Printhead option first to save ink.
- If the ink levels are too low, you must replace the ink cartridges before you can clean the printhead nozzles.

## Using the printer control panel

- 1 From the printer control panel, press .
- 2 Press the arrow buttons to scroll to **Maintenance**, and then press **OK**.
- 3 Press the arrow buttons to scroll to **Clean Printhead** or **Deep Clean Printhead**, and then press **OK**.
- 4 Press **OK** to clean the printhead nozzles.  
A cleaning page prints.

## Using the printer software

- 1 Click  or **Start**.
- 2 Click **All Programs** or **Programs**, and then select the printer program folder from the list.
- 3 Select **Printer Home**.
- 4 From the Maintenance tab, click **Clean Cartridges**.

## Cleaning the exterior of the printer

- 1 Make sure that the printer is turned off and unplugged from the wall outlet.



**CAUTION—SHOCK HAZARD:** To avoid the risk of electric shock when cleaning the exterior of the printer, unplug the power cord from the wall outlet and disconnect all cables to the printer before proceeding.

- 2 Remove paper from the paper support and paper exit tray.
- 3 Dampen a clean, lint-free cloth with water.

**Warning—Potential Damage:** Do not use household cleaners or detergents, as they may damage the finish of the printer.

**4** Wipe only the outside of the printer, making sure to remove any ink residue that has accumulated on the paper exit tray.

**Warning—Potential Damage:** Using a damp cloth to clean the interior may cause damage to your printer.

**5** Make sure the paper support and paper exit tray are dry before beginning a new print job.

## Cleaning the scanner glass

**1** Dampen a clean, lint-free cloth with water.

**2** Gently wipe the scanner glass clean.

**Note:** Make sure all ink or corrective fluid on a document is dry before placing the document on the scanner glass.

# Troubleshooting

## Before you troubleshoot

Use this checklist to solve most printer problems:

- Make sure the power cord is plugged into the printer and into a properly grounded electrical outlet.
- Make sure the printer is not plugged into any surge protectors, uninterrupted power supplies, or extension cords.
- Make sure the printer is turned on.
- Make sure the printer is securely connected to the host computer, print server, or other network access point.
- Check the printer for error messages, and resolve any errors.
- Check for paper jam messages, and clear any jams.
- Check the ink cartridges, and install new cartridges if necessary.
- Use the Service Center to locate and solve the problem (Windows only).
- Turn the printer off, wait about 10 seconds, and then turn the printer back on.

## Using the Service Center to solve printer problems

The Service Center provides step-by-step troubleshooting help and contains links to printer maintenance tasks and customer support.

To open the Service Center, use one of these methods:

Method 1	Method 2
If it appears on an error message dialog, click the <b>For additional assistance, use the Service Center</b> link.	<ol style="list-style-type: none"><li>1 Click  or <b>Start</b>.</li><li>2 Click <b>All Programs</b> or <b>Programs</b>, and then select the printer program folder from the list.</li><li>3 Select <b>Printer Home</b>.</li><li>4 From the Support tab, select <b>Service Center</b>.</li></ol>

## If Troubleshooting does not solve your problem

Visit our Web site at [support.dell.com](http://support.dell.com) to find the following:

- Live online technical support
- Contact numbers for telephone technical support

## Setup troubleshooting

- “Incorrect language appears on the display” on page 102
- “Printhead error” on page 102
- “Software did not install” on page 103
- “Print job does not print or is missing pages” on page 104

- "Printer is printing blank pages" on page 105
- "Printer is busy or does not respond" on page 105
- "Cannot delete documents from the print queue" on page 106
- "Cannot print through USB" on page 106



## Incorrect language appears on the display

If the "Before you troubleshoot" checklist does not solve the problem, then try one or more of the following:

### CHANGE THE LANGUAGE USING THE PRINTER MENUS

- 1 From the printer control panel, press .
- 2 Press the arrow buttons to scroll to **Defaults**, and then press **OK**.
- 3 Press the arrow buttons to scroll to **Set Defaults**, and then press **OK**.
- 4 Press the arrow buttons to scroll to **Use Factory**, and then press **OK**.
- 5 Complete the initial printer setup.

### CHANGE THE LANGUAGE USING A BUTTON COMBINATION (IF YOU CANNOT READ THE CURRENT LANGUAGE)

- 1 Turn the printer off.
- 2 Press and hold down  and , and then press  to turn the printer on.  
The printer resets and starts the initial printer setup.
- 3 Complete the initial printer setup.

## Printhead error

If the "Before you troubleshoot" checklist does not solve the problem, then try the following:

### REMOVE AND REINSERT THE PRINTHEAD

- 1 Open the printer and lift the latch.

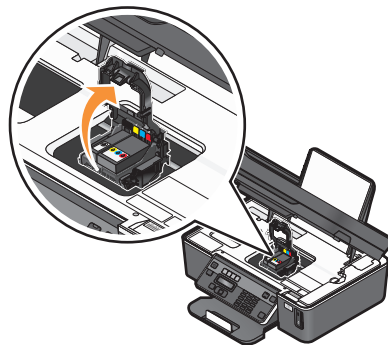

2 Remove the printhead.

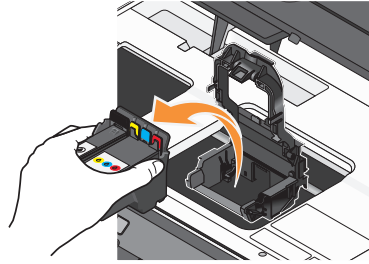

3 Wipe the printhead contacts using a clean, lint-free cloth.

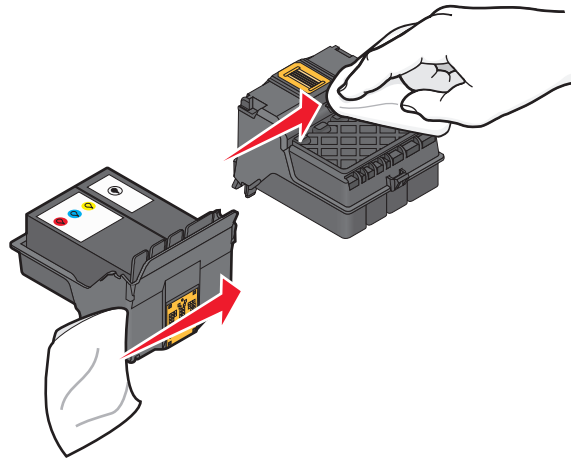

4 Reinsert the printhead.

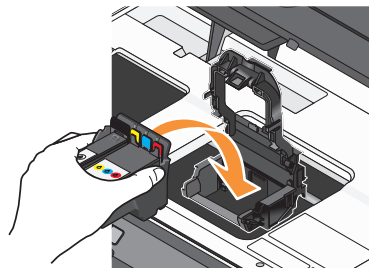

**Note:** If removing and reinserting the printhead does not resolve the error, then contact technical support.

## Software did not install

If you encountered problems while installing, or if your printer does not appear in the list in the Printers folder or as a printer option when sending a print job, then try removing and reinstalling the software.

Before you reinstall the software, do the following:

**MAKE SURE THAT YOUR COMPUTER MEETS THE MINIMUM SYSTEM REQUIREMENTS LISTED ON THE PRINTER BOX**

**TEMPORARILY DISABLE SECURITY PROGRAMS IN WINDOWS BEFORE INSTALLING THE SOFTWARE**

## CHECK THE USB CONNECTION

- 1 Check the USB cable for any obvious damage. If the cable is damaged, then use a new one.
- 2 Firmly plug the square end of the USB cable into the back of the printer.
- 3 Firmly plug the rectangular end of the USB cable into the USB port of the computer.

The USB port is marked with a  USB symbol.

## RECONNECT THE PRINTER POWER SUPPLY

- 1 Turn off the printer, and then unplug the power cord from the wall outlet.
- 2 Gently remove the power supply from the printer, and then reinsert it.
- 3 Plug the power cord into the wall outlet, and then turn on the printer.

## Print job does not print or is missing pages

If the "Before you troubleshoot" checklist does not solve the problem, then try one or more of the following:

### MAKE SURE THE INK CARTRIDGES ARE INSERTED CORRECTLY

- 1 Turn the printer on, and then open the printer.
- 2 Make sure the cartridges are inserted correctly.  
The cartridges should *click* firmly into the matching color slot of the printhead.
- 3 Close the printer.

### SELECT YOUR PRINTER FROM THE PRINT DIALOG BEFORE SENDING THE PRINT JOB

### MAKE SURE THE PRINT JOB IS NOT PAUSED

### MAKE SURE YOUR PRINTER IS SET AS THE DEFAULT PRINTER

### RECONNECT THE PRINTER POWER SUPPLY

- 1 Turn off the printer, and then unplug the power cord from the wall outlet.
- 2 Gently remove the power supply from the printer, and then reinsert it.
- 3 Plug the power cord into the wall outlet, and then turn on the printer.

### REMOVE AND RECONNECT THE USB CABLE CONNECTED TO YOUR PRINTER

## CHECK THE USB CONNECTION

- 1 Check the USB cable for any obvious damage. If the cable is damaged, then use a new one.
- 2 Firmly plug the square end of the USB cable into the back of the printer.



- 3 Firmly plug the rectangular end of the USB cable into the USB port of the computer.  
The USB port is marked with a  USB symbol.

## REMOVE AND REINSTALL THE PRINTER SOFTWARE

### Printer is printing blank pages

Blank pages may be caused by improperly installed ink cartridges.

## REINSTALL THE INK CARTRIDGES AND DEEP CLEAN AND ALIGN THE PRINTHEAD

- 1 Reinstall the ink cartridges, see “Replacing ink cartridges” on page 13 for more information.  
If the cartridges do not seem to fit, make sure the printhead is properly seated, and then try installing the cartridges again.
- 2 Load plain paper.
- 3 From the printer control panel, press .
- 4 Press the arrow buttons to scroll to **Maintenance**, and then press **OK**.
- 5 Press the arrow buttons to scroll to **Deep Clean Printhead**, and then press **OK**.  
A cleaning page prints.
- 6 Press the arrow buttons to scroll to **Align Printer**, and then press **OK**.  
An alignment page prints.

**Note:** Do not remove the alignment page until printing is finished.

### Printer is busy or does not respond

If the "Before you troubleshoot" checklist does not solve the problem, then try one or more of the following:

## MAKE SURE THE PRINTER IS NOT IN POWER SAVER MODE

If the power light is blinking on and off slowly, then the printer is in Power Saver mode. Press  to wake up the printer.

If the printer will not come out of Power Saver mode, then reset the power:

- 1 Unplug the power cord from the wall outlet, and then wait 10 seconds.
- 2 Insert the power cord into the wall outlet, and then turn on the printer.

If this problem persists, then check our Web site for updates for your printer software or firmware.

## RECONNECT THE PRINTER POWER SUPPLY

- 1 Turn off the printer, and then unplug the power cord from the wall outlet.
- 2 Gently remove the power supply from the printer, and then reinsert it.
- 3 Plug the power cord into the wall outlet, and then turn on the printer.

## Cannot delete documents from the print queue

If you have jobs stuck in the print queue and cannot delete them to get other jobs to print, then the computer and printer may not be communicating.

### RESTART THE COMPUTER AND TRY AGAIN

## Cannot print through USB

If the "Before you troubleshoot" checklist does not solve the problem, then try one or more of the following:

### CHECK THE USB CONNECTION

- 1 Check the USB cable for any obvious damage. If the cable is damaged, then use a new one.
- 2 Firmly plug the square end of the USB cable into the back of the printer.
- 3 Firmly plug the rectangular end of the USB cable into the USB port of the computer.  
The USB port is marked with a  USB symbol.

### MAKE SURE THE USB PORT IS ENABLED IN WINDOWS

- 1 Click , or click **Start** and then click **Run**.
- 2 In the Start Search or Run box, type `devmgmt.msc`.
- 3 Press **Enter**, or click **OK**.  
The Device Manager opens.
- 4 Click the plus sign (+) beside Universal Serial Bus controllers.  
If USB Host Controller and USB Root Hub are listed, then the USB port is enabled.

For more information, see the computer documentation.

### REMOVE AND REINSTALL THE PRINTER SOFTWARE

## Jams and misfeeds troubleshooting

- "Paper jam in the printer" on page 106
- "Paper jam in the paper support" on page 107
- "Paper jam in the ADF (selected models only)" on page 107
- "Paper or specialty media misfeeds" on page 108

## Paper jam in the printer

**Note:** The parts inside the printer are sensitive. Avoid unnecessarily touching these parts while clearing jams.

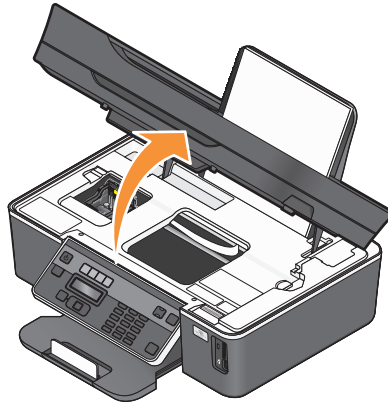

- 1 Press  to turn off the printer.
- 2 Check the paper tray or lift the scanner unit to check for jammed paper.



- 3 Firmly grasp the paper, and then gently pull it out.  
**Note:** Be careful not to tear the paper while removing it.
- 4 Press  to turn the printer back on.

## Paper jam in the paper support

**Note:** The parts inside the printer are sensitive. Avoid unnecessarily touching these parts while clearing jams.

- 1 Press  to turn off the printer.
- 2 Firmly grasp the paper, and then gently pull it out.  
**Note:** Be careful not to tear the paper while removing it.
- 3 Press  to turn the printer back on.

## Paper jam in the ADF (selected models only)

- 1 Press the button, and lift the ADF door.

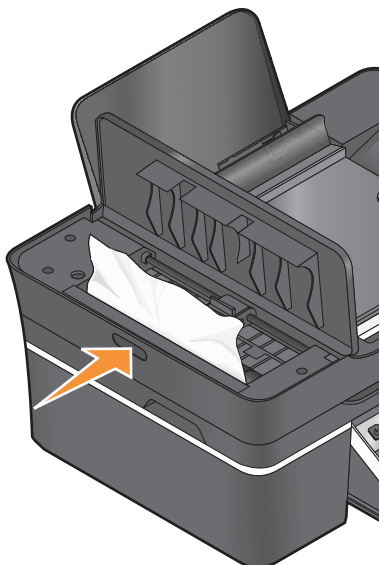

- 2 Firmly grasp the paper, and gently pull it out.
- 3 Close the ADF door.
- 4 Press **OK**.

## Paper or specialty media misfeeds

These are possible solutions if paper or specialty media misfeeds or skews, or if multiple sheets feed or stick together. Try one or more of the following:

### CHECK PAPER CONDITION

Use only new, unwrinkled paper.

### CHECK PAPER LOADING

- Load a smaller amount of paper into the printer.
- Load paper with the print side faceup. (If you are not sure which side is the printable side, see the instructions that came with the paper.)
- Check the loading instructions for your paper or specialty media.

### REMOVE EACH PAGE AS IT IS PRINTED

### ADJUST THE PAPER GUIDES TO FIT THE LOADED PAPER

## Print troubleshooting

- "Poor quality at the edges of the page" on page 108
- "Streaks or lines on printed image" on page 109
- "Print speed is slow" on page 109
- "Computer slows down when printing" on page 110

## Poor quality at the edges of the page

If the "Before you troubleshoot" checklist does not solve the problem, then try one or more of the following:

### CHECK MINIMUM PRINT SETTINGS

Unless you are using the borderless feature, use these minimum print margin settings:

- Left and right margins:
  - 6.35 mm (0.25 in.) for letter-size paper
  - 3.37 mm (0.133 in.) for all paper sizes except letter
- Top margin: 1.7 mm (0.067 in.)
- Bottom margin: 12.7 mm (0.5 in.)

## **SELECT THE BORDERLESS PRINT FEATURE**

- 1 With a document or photo open, click **File → Print**.
- 2 Click **Properties, Preferences, Options, or Setup**.
- 3 From the Paper Options section of the Print Setup tab, select **Borderless**.

## **Streaks or lines on printed image**

If the "Before you troubleshoot" checklist does not solve the problem, then try one or more of the following:

### **CHECK THE INK LEVELS**

Replace low or empty ink cartridges.

### **SELECT A HIGHER PRINT QUALITY FROM THE PRINTER SOFTWARE**

### **MAKE SURE THE INK CARTRIDGES ARE PROPERLY INSTALLED**

### **ALIGN THE PRINTHEAD**

### **CLEAN OR DEEP CLEAN THE PRINTHEAD NOZZLES**

**Note:** If these solutions do not remove the streaks or lines on the printed image, then contact technical support.

## **Print speed is slow**

If the "Before you troubleshoot" checklist does not solve the problem, then try one or more of the following:

### **MAXIMIZE COMPUTER PROCESSING SPEED**

- Close all applications not in use.
- Minimize the number and size of graphics and images in the document.
- Remove as many unused fonts as possible from your system.

### **ADD MEMORY**

Consider purchasing more RAM.

### **SELECT A LOWER PRINT QUALITY FROM THE PRINTER SOFTWARE**

### **MANUALLY SELECT A PAPER TYPE THAT MATCHES THE TYPE OF PAPER YOU ARE USING**

### **REMOVE AND REINSTALL THE PRINTER SOFTWARE**

## Computer slows down when printing

These are possible solutions. Try one of the following:

### IF YOU ARE USING A **USB** CONNECTION, THEN TRY A DIFFERENT **USB** CABLE

### IF YOU ARE ON A NETWORK, THEN RESET THE POWER OF THE ACCESS POINT (ROUTER)

- 1 Unplug the power cord from the access point.
- 2 Wait ten seconds, and then insert the power cord.

## Copy and scan troubleshooting

- “Copier or scanner does not respond” on page 110
- “Scanner unit does not close” on page 110
- “Poor copy or scanned image quality” on page 110
- “Partial copies or scans of documents or photos” on page 111
- “Scan was not successful” on page 111
- “Scanning takes too long or freezes the computer” on page 111
- “Cannot scan to a computer over a network” on page 111

## Copier or scanner does not respond

If the "Before you troubleshoot" checklist does not solve the problem, then try one or more of the following:

### SET YOUR PRINTER AS THE DEFAULT PRINTER

### REMOVE AND REINSTALL THE PRINTER SOFTWARE

## Scanner unit does not close

- 1 Lift the scanner unit.
- 2 Remove any obstruction keeping the scanner unit open.
- 3 Lower the scanner unit.

## Poor copy or scanned image quality

If the "Before you troubleshoot" checklist does not solve the problem, then try one or more of the following:

### CLEAN THE SCANNER GLASS

### ADJUST THE SCAN QUALITY FROM THE PRINTER SOFTWARE

### REVIEW THE TIPS FOR COPYING, SCANNING, AND IMPROVING PRINT QUALITY

**USE A CLEARER VERSION OF THE ORIGINAL DOCUMENT OR IMAGE**

**MAKE SURE THE DOCUMENT OR PHOTO IS LOADED FACEDOWN ON THE SCANNER GLASS AND IN THE CORRECT CORNER**

## **Partial copies or scans of documents or photos**

If the "Before you troubleshoot" checklist does not solve the problem, then try one or more of the following:

**MAKE SURE THE DOCUMENT OR PHOTO IS LOADED FACEDOWN ON THE SCANNER GLASS AND IN THE CORRECT CORNER**

**SELECT A PAPER SIZE FROM THE PRINTER SOFTWARE THAT MATCHES THE LOADED PAPER**

**MAKE SURE THE ORIGINAL SIZE SETTING MATCHES THE SIZE OF THE DOCUMENT YOU ARE SCANNING**

## **Scan was not successful**

If the "Before you troubleshoot" checklist does not solve the problem, then try one or more of the following:

### **CHECK THE USB CONNECTION**

- 1 Check the USB cable for any obvious damage. If the cable is damaged, then use a new one.
- 2 Firmly plug the square end of the USB cable into the back of the printer.
- 3 Firmly plug the rectangular end of the USB cable into the USB port of the computer.

The USB port is marked with a  USB symbol.

### **RESTART THE COMPUTER**

## **Scanning takes too long or freezes the computer**

If the "Before you troubleshoot" checklist does not solve the problem, then try one or more of the following:

**CLOSE OTHER SOFTWARE PROGRAMS THAT ARE NOT BEING USED**

**USE A LOWER SCANNING RESOLUTION**

## **Cannot scan to a computer over a network**

If the "Before you troubleshoot" checklist does not solve the problem, then try one or more of the following:

**MAKE SURE THE PRINTER AND THE DESTINATION COMPUTER ARE CONNECTED TO THE SAME NETWORK**

## MAKE SURE THE PRINTER SOFTWARE IS INSTALLED ON THE DESTINATION COMPUTER

# Fax troubleshooting

- “Fax troubleshooting checklist” on page 112
- “Cannot send faxes” on page 113
- “Cannot receive faxes” on page 115
- “Cannot run the fax software” on page 116
- “Fax error messages on the printer control panel” on page 116

For detailed descriptions of common terms and tasks, see the following:

- “Setting up the printer to fax” on page 57
- “Faxing FAQ” on page 73

## Fax troubleshooting checklist

If you encounter problems sending and receiving faxes, then check the connection first:

- 1** Check for a dial tone on the telephone line by plugging an analog telephone into the wall jack, DSL filter, VoIP device, or cable modem where you connected the printer. Make sure you plug the telephone into the same port. If you do not hear a dial tone, then contact your line provider.
- 2** While the printer is connected to the telephone line, check for a dial tone by plugging an analog telephone into the  port of the printer. If you do not hear a dial tone, then use the checklist below. Listen for a dial tone after checking each item. If you hear a dial tone but still have problems sending and receiving faxes, then see the other topics in this section.

## Connection checklist

- Make sure that the printer and other devices on the line (if applicable) are set up and configured correctly according to your setup scenario.
- Make sure that the cables are connected to the correct ports.
- Make sure that the cables are securely plugged in.

Check the cable connections for the following hardware, if applicable:

Power supply	Answering machine	Cable modem	Splitter
Telephone	VoIP adapter	DSL filter	RJ-11 adapter

- If the printer is connected to a Digital Subscriber Line, then make sure you are using a DSL filter for the printer.
- If the printer is connected to a VoIP adapter or cable modem, then make sure that the printer is plugged into the first phone port.
- If you are using a splitter, then make sure that you are using a phone splitter. Do *not* use a line splitter.



## Cannot send faxes

If the “Fax troubleshooting checklist” does not solve the problem, then try one or more of the following:

### MAKE SURE THAT YOU HAVE REGISTERED YOUR USER INFORMATION IN THE PRINTER

If you did not enter your user information during initial setup, then enter your fax name and fax number. In some countries, you cannot send a fax without entering your fax name or company name. Some fax machines also block unknown faxes or faxes without sender information.

### DECREASE THE TRANSMISSION SPEED OF THE FAX MODEM

The modem of the printer can transmit data at 33,600 bps. This is the maximum speed at which the printer can send and receive faxes. It is not necessary, however, to set the modem to its fastest transmission capability. The speed of the modem of the receiving fax machine must match or be greater than the speed at which you are sending your fax. Otherwise, your fax will not be received.

To decrease the transmission speed of the modem:

- 1 From the printer control panel, press .
- 2 Press the arrow buttons to scroll to **Fax Setup**, and then press **OK**.
- 3 Press the arrow buttons to scroll to **Dialing and Sending**, and then press **OK**.
- 4 Press the arrow buttons to scroll to **Max Send Speed**, and then press **OK**.
- 5 Select a sending speed, and then press **OK**.

### SET THE PRINTER TO SCAN THE ORIGINAL DOCUMENT BEFORE DIALING THE NUMBER

The printer does not automatically redial if you set it to scan the original document after dialing the number.

Set the printer to scan before dialing so that you do not have to scan the document again if the fax fails. The scanned document is saved in the printer memory. The printer can then retrieve it and automatically redial the number.

To set the printer to scan before dialing:

- 1 From the printer control panel, press .
- 2 Press the arrow buttons to scroll to **Fax Setup**, and then press **OK**.
- 3 Press the arrow buttons to scroll to **Dialing and Sending**, and then press **OK**.
- 4 Press the arrow buttons to scroll to **Scan**, and then press **OK**.
- 5 Press the arrow buttons to scroll to **Before Dial**, and then press **OK**.

### ENABLE ERROR CORRECTION

Errors and blurs may appear in the faxed document if there is too much noise on the line. This option enables the printer to transmit the bad blocks of data again and correct the errors. When a fax has too many errors, the fax may be rejected by the receiving fax machine.

To make sure that error correction is enabled:

- 1 From the printer control panel, press .
- 2 Press the arrow buttons to scroll to **Fax Setup**, and then press **OK**.
- 3 Press the arrow buttons to scroll to **Dialing and Sending**, and then press **OK**.
- 4 Press the arrow buttons to scroll to **Error Correction**, and then press **OK**.
- 5 Check to see if error correction is set to On.  
If it is not set to On, press the arrow buttons to select **On**, and then press **OK**.

## ENABLE AUTOMATIC FAX CONVERSION

If the receiving fax machine does not support color fax, then this option automatically converts the outgoing color fax to black and white. It also automatically reduces the resolution of the fax to a resolution that the receiving machine can support.

To make sure that automatic fax conversion is enabled:

- 1 From the printer control panel, press .
- 2 Press the arrow buttons to scroll to **Fax Setup**, and then press **OK**.
- 3 Press the arrow buttons to scroll to **Dialing and Sending**, and then press **OK**.
- 4 Press the arrow buttons to scroll to **Auto Fax Convert**, and then press **OK**.
- 5 Check to see if automatic fax conversion is set to On.  
If it is not set to On, press the arrow buttons to select **On**, and then press **OK**.

## MAKE SURE THAT THE DIAL PREFIX SETTING IS CORRECT

The dialing prefix is the number or series of numbers that you press before you can dial the actual fax number or telephone number. If the printer is in an office setting or in a private branch exchange, this can be a specific number that you need to press so you can make a call outside the office.

Make sure that the dial prefix entered in the printer is correct for your network.

To check the dial prefix setting:

- 1 From the printer control panel, press .
- 2 Press the arrow buttons to scroll to **Fax Setup**, and then press **OK**.
- 3 Press the arrow buttons to scroll to **Dialing and Sending**, and then press **OK**.
- 4 Press the arrow buttons to scroll to **Dial Prefix**, and then press **OK**.
- 5 Press the arrow buttons to view the prefix.
- 6 If the prefix is not correct, enter the correct prefix, and then press **OK**.

## Cannot receive faxes

If the “Fax troubleshooting checklist” does not solve the problem, then try one or more of the following:

### MAKE SURE THAT YOU HAVE CONFIGURED THE CORRECT SETTINGS FOR YOUR SETUP

The fax settings depend on whether the printer is connected to its own fax line or shares the line with other devices.

If the printer is sharing the telephone line with an answering machine, then make sure that the following are set:

- Auto Answer is On.
- The printer picks up on a greater number of rings than the answering machine.
- The printer picks up on the correct distinctive ring (if you subscribe to a distinctive ring service).

If the printer is sharing the telephone line with a telephone subscribed to voice mail, then make sure that the following are set:

- Auto Answer is Off (if you have only one number on the telephone line).
- The printer picks up on the correct distinctive ring (if you subscribe to a distinctive ring service).

### MAKE SURE THAT THE PRINTER IS CONNECTED TO AN ANALOG PORT

The printer is an analog device. If you are using a PBX system, then make sure that the printer is connected to an analog port on the PBX. You may need a digital line converter that converts digital signals into analog signals.

### MAKE SURE THAT THE PRINTER MEMORY IS NOT FULL

The printer saves an incoming fax to the printer memory before it prints the fax. If the printer runs out of ink or runs out of paper while receiving the fax, then the printer saves the fax so you can print it later. However, if the printer memory is full, then the printer may not be able to receive more incoming faxes. An error message appears on the display when the printer memory is full. Resolve the error to free up space in the printer memory.

### MAKE SURE THAT FAX FORWARDING IS DISABLED

You may have turned on Fax Forwarding. Disable this option so that the printer can receive the fax.

- 1 From the printer control panel, press .
- 2 Press the arrow buttons to scroll to **Fax Setup**, and then press **OK**.
- 3 Press the arrow buttons to scroll to **Ring and Answering**, and then press **OK**.
- 4 Press the arrow buttons to scroll to **Fax Forward**, and then press **OK**.
- 5 Press the arrow buttons to scroll to **Off**, and then press **OK**.

### INCREASE THE RINGER VOLUME

If you set the printer to receive faxes manually (Auto Answer Off), then increase the ringer volume.

### MAKE SURE THAT YOU HAVE THE CORRECT MANUAL ANSWER CODE

If you set the printer to receive faxes manually (Auto Answer Off), then you need to press the correct code when a fax comes in so that the printer can receive it.

To retrieve the correct code:

- 1 From the printer control panel, press .
- 2 Press the arrow buttons to scroll to **Fax Setup**, and then press **OK**.
- 3 Press the arrow buttons to scroll to **Ring and Answering**, and then press **OK**.
- 4 Press the arrow buttons to scroll to **Manual Pickup Code**, and then press **OK**.
- 5 Copy the manual answer code that appears on the display.

## Cannot run the fax software

The printer must be connected to a telephone, DSL, VoIP, or cable service before you can configure the fax settings in the fax software.

### MAKE SURE THE PRINTER IS CONNECTED TO A TELEPHONE LINE

You need to connect the printer to your telephone line (through a standard wall jack, a DSL filter, a VoIP adapter, or a cable modem) before you can open the fax software and configure the fax settings.

### MAKE SURE THAT THE PRINTER IS CONNECTED TO THE COMPUTER

### MAKE SURE THAT THE PRINTER IS NOT IN POWER SAVER MODE

## Fax error messages on the printer control panel

Error Message:	What it indicates:	Possible solutions:
<b>Remote Fax Error</b>	The receiving fax machine cannot receive the fax. The error on the receiving end could be due to several factors.	<ul style="list-style-type: none"><li>• Resend the fax. There may have been a problem with the quality of the connection.</li><li>• Decrease the transmission speed of your fax modem.</li><li>• Register your user information. In some countries, you cannot send a fax without registering your fax name and fax number. Some fax machines also block faxes without sender information.</li></ul>
<b>Fax Mode Unsupported</b>	The receiving fax machine does not support color fax or the scan resolution of the document that you are sending.	<ul style="list-style-type: none"><li>• Enable Auto Fax Conversion. The printer automatically converts color faxes to black and lowers the scan resolution of the document.</li><li>• Lower the fax quality.</li><li>• Reformat the document on Letter-size paper.</li></ul>

Error Message:	What it indicates:	Possible solutions:
<b>Unsupported Compression</b>	The fax modem of the receiving fax machine does not support data compression. Fax modems compress data to speed up transmission, but the receiving fax modem needs to have the same compression code.	<ul style="list-style-type: none"> <li>• Lower the transmission speed of the fax modem, and then resend the fax.</li> <li>• Enable Auto Fax Conversion.</li> </ul>
<b>Unsupported Resolution</b>	The receiving fax machine does not support the scan resolution of the document that you are sending.	<ul style="list-style-type: none"> <li>• Lower the fax quality.</li> <li>• Enable Auto Fax Conversion.</li> </ul>
<b>Unrecoverable Fax Error</b>	The fax modem encountered critical errors.	Turn off the printer, turn it back on, and then resend the fax.
<b>Fax Modem Error</b>	The fax modem of the printer may be busy, or the fax modem may have encountered problems during transmission.	Turn off the printer, turn it back on, and then resend the fax.
<b>Phone Line is connected to the incorrect jack on the back of the machine.</b>	The telephone cable is connected to the wrong port on the back of the printer.	Connect the phone cable to the  port on the back of the printer.
<b>Digital line detected</b>	The printer is connected to a digital line.	<p>The printer is an analog device and must be connected to an analog line. To connect the printer to a digital line, you must use a digital line converter or a filter.</p> <p>For more information, see the "Setting up the printer to fax" section.</p>
<b>Failed to Connect Phone Line Error Phone Line Not Connected</b>	The printer cannot detect a dial tone.	See the "Fax troubleshooting checklist."
<b>Phone Line Busy</b>	Your telephone line or the telephone line of the receiving fax machine is busy. This happens especially if the printer is sharing the line with other devices (telephone, answering machine).	<ul style="list-style-type: none"> <li>• Set the printer to redial.</li> <li>• Increase the time between the redial attempts.</li> <li>• Place a test call to the number to which you want to send a fax to make sure that it is working correctly.</li> <li>• If the telephone line is being used by another device, then wait until the other device is finished before sending the fax.</li> <li>• Schedule to resend the fax at a later time.</li> <li>• Set the printer to scan before dialing. The scanned document is saved in the printer memory. The printer can then retrieve it and automatically redial the number.</li> </ul>

Error Message:	What it indicates:	Possible solutions:
No Answer	Auto Answer may have been turned off on the receiving fax machine.	<ul style="list-style-type: none"> <li>• Verify the number, and then resend the fax.</li> <li>• Set the printer to redial. <b>Note:</b> Depending on your country or region, there may be a limit on the number of redial attempts, regardless of the redial settings that you set in your printer.</li> <li>• Schedule to resend the fax at a later time.</li> </ul>
No Caller ID Call Stopped	Your printer stopped the call because the incoming fax has no sender information. You may have chosen to block faxes with no Caller ID or faxes without Caller IDs are not allowed in your country or region.	Disable Block No-ID.

To troubleshoot error messages in the fax software, click **Help** to view the help information for the fax software.

## Memory card troubleshooting

- “Memory card troubleshooting checklist” on page 118
- “Nothing happens when a memory card is inserted” on page 118
- “Cannot print documents from a memory card or flash drive” on page 119
- “Photos do not transfer from a memory card across a wireless network” on page 119

### Memory card troubleshooting checklist

Before you troubleshoot, use the following checklist to solve most memory card problems:

- Make sure that the memory card you are using can be used in the printer.
- Make sure you insert the memory card into the correct slot.
- Make sure the memory card is not damaged.
- Make sure memory card contains supported file types.

### Nothing happens when a memory card is inserted

If the "Memory card troubleshooting checklist" does not solve the problem, then try one or more of the following:

#### REINSERT THE MEMORY CARD

The memory card may have been inserted too slowly. Remove and then reinsert the memory card quickly.

#### CHECK THE USB CONNECTION

- 1 Check the USB cable for any obvious damage. If the cable is damaged, then use a new one.
- 2 Firmly plug the square end of the USB cable into the back of the printer.

- 3 Firmly plug the rectangular end of the USB cable into the USB port of the computer.

The USB port is marked with a  USB symbol.

## CHECK THE NETWORK CONNECTION

If the printer and computer are connected over a network, then make sure that the correct host and device are communicating. Select the printer from the computer or the computer from the printer.

## Cannot print documents from a memory card or flash drive

If the "Memory card troubleshooting checklist" does not solve the problem, then try the following:

### CHECK THE USB CONNECTION

- 1 Check the USB cable for any obvious damage. If the cable is damaged, then use a new one.
- 2 Firmly plug the square end of the USB cable into the back of the printer.
- 3 Firmly plug the rectangular end of the USB cable into the USB port of the computer.

The USB port is marked with a  USB symbol.

### CHECK THE NETWORK CONNECTION

If the printer and computer are connected over a network, then make sure that the correct host and device are communicating. Select the printer from the computer or the computer from the printer.

## Photos do not transfer from a memory card across a wireless network

If the "Memory card troubleshooting checklist" does not solve the problem, then try one or more of the following:

**MAKE SURE THAT BOTH THE PRINTER AND THE DESTINATION COMPUTER ARE TURNED ON AND READY**

**SET YOUR PRINTER AS THE DEFAULT PRINTER FROM THE DESTINATION COMPUTER**

**SELECT THE CORRECT COMPUTER NAME FROM THE SCAN DESTINATION LIST ON THE PRINTER**

**MAKE SURE YOUR WIRELESS NETWORK IS CONNECTED AND ACTIVE**

If your wireless connection is down, then use a USB cable to connect your printer to your computer.

## Wireless troubleshooting

- "Wireless troubleshooting checklist" on page 120
- "Resetting the wireless settings to factory defaults" on page 120
- "Cannot print over wireless network" on page 121



- “The Continue button is unavailable” on page 123
- “Cannot print and there is a firewall on the computer” on page 124
- “Wi-Fi indicator light is not lit” on page 124
- “Wi-Fi indicator light is green but the printer does not print (Windows only)” on page 125
- “Wi-Fi indicator light is still orange” on page 126
- “Wi-Fi indicator light is blinking orange during installation” on page 127
- “Wireless print server not installed” on page 130
- ““Communication not available” message displays when printing wirelessly” on page 130
- “Communication with printer lost when connected to Virtual Private Network (VPN)” on page 132
- “Resolving intermittent wireless communications issues” on page 132

## Wireless troubleshooting checklist

Before beginning to troubleshoot the wireless printer, verify the following:

- The printer, the computer, and the wireless access point are all plugged in and turned on.
- The wireless network is working properly.  
Try accessing other computers on your wireless network.  
If your network has Internet access, try connecting to the Internet over a wireless connection.
- Your SSID is correct.  
Print a network setup page to verify the SSID the printer is using.  
If you are not sure if your SSID is correct, then run the wireless setup again.
- Your WEP key or WPA passphrase is correct (if your network is secure).  
Log into the wireless access point (wireless router) and check the security settings.  
A security key is like a password. All devices on the same wireless network using WEP, WPA, or WPA2 share the same security key.  
If you are not sure if your security information is correct, run the wireless setup again.
- The printer and the computer are within the range of the wireless network.  
For most networks, the printer and the computer should be within 100 feet (30 meters) of the wireless access point (wireless router).
- The Wi-Fi indicator light is lit and is solid green.
- The printer driver is installed on the computer from which you are performing a task.
- The correct printer port is selected.
- The computer and printer are both connected to the same wireless network.
- The printer is located away from obstacles or electronic devices that could interfere with the wireless signal.  
Make sure the printer and wireless access point are not separated by poles, walls, or support columns containing metal or concrete.  
Many devices can interfere with the wireless signal, including baby monitors, motors, cordless phones, security system cameras, other wireless networks, and some Bluetooth devices.

## Resetting the wireless settings to factory defaults

- 1 From the printer control panel, press .
- 2 Press the arrow buttons to scroll to **Network Setup**, and then press .



**3** Press the arrow buttons to scroll to **Reset Network Adapter Defaults**, and then press **OK**.

**4** Press the arrow buttons to scroll to **Yes**, and then press **OK**.

The printer wireless settings are reset to factory default settings. To verify, print a network setup page.

## Cannot print over wireless network

If you encountered problems while installing, or if your printer does not appear in the printers folder or as a printer option when sending a print job, then you can try uninstalling and reinstalling the software.

Before you reinstall the software, check the troubleshooting checklist, and then do the following:

### MAKE SURE YOUR COMPUTER IS CONNECTED TO YOUR WIRELESS ACCESS POINT (WIRELESS ROUTER)

- See if you have access to the Internet by opening your Web browser and accessing any site.
- If there are other computers or resources on your wireless network, then check to see if you can access them from your computer.

### MOVE THE COMPUTER AND/OR PRINTER CLOSER TO THE WIRELESS ROUTER

Although the possible distance between devices in 802.11b or 802.11g networks is 300 feet, the maximum range for optimal performance is generally 100-150 feet.

### MOVE YOUR ACCESS POINT AWAY FROM OTHER ELECTRONIC DEVICES

There may be temporary interference from electronic devices such as microwave ovens or other appliances, cordless phones, baby monitors, and security system cameras. Make sure your access point is not positioned too closely to these devices.

### MAKE SURE THAT YOUR COMPUTER AND PRINTER ARE CONNECTED TO THE SAME WIRELESS NETWORK

If the printer is not on the same wireless network as the computer, you will not be able to print wirelessly. The SSID of the printer must match the SSID of the computer, if the computer is already connected to the wireless network.

- 1** Obtain the SSID of the network that the computer is connected to.
  - a** Type the IP address of your wireless access point (wireless router) into the address field of your Web browser.

If you do not know the IP address of the wireless access point:

- 1** Click , or click **Start** and then click **Run**.
  - 2** In the Start Search or Run box, type **cmd**.
  - 3** Press **Enter** or click **OK**.  
The Command Prompt window opens.
  - 4** Type **ipconfig**, and then press **Enter**. Check the Wireless Network Connection section:
    - The "Default Gateway" entry is typically the wireless access point .
    - The IP address appears as four sets of numbers separated by periods, such as 192.168.2.134.
- b** Type the user name and password of the router when prompted.
  - c** Click **OK**.

- d** On the main page, click **Wireless** or any other selection where settings are stored. The SSID will be displayed.
- e** Write down the SSID.

**Note:** Make sure you copy it exactly, including any capital letters.

- 2** Print the printer network setup page.

In the Wireless section, look for **SSID**.

- 3** Compare the SSID of the computer and SSID of the printer.

If the SSIDs are the same, then the computer and the printer are connected to the same wireless network.

If the SSIDs are not the same, then run the utility again to set up the printer on the wireless network used by the computer.

## CHECK YOUR WEP KEY OR WPA PASSPHRASE

If your wireless access point is using Wireless Equivalent Privacy (WEP) security, then the WEP key should be:

- Exactly 10 or 26 hexadecimal characters. Hexadecimal characters are A–F, a–f, and 0–9.

*or*

- Exactly 5 or 13 ASCII characters. ASCII characters are letters, numbers, and symbols found on a keyboard. ASCII characters in a WEP key are case-sensitive.

If your wireless access point is using Wi-Fi Protected Access (WPA) security, then the WPA passphrase should be:

- From 8 to 63 ASCII characters. ASCII characters in a WPA passphrase are case-sensitive.

*or*

- Exactly 64 hexadecimal characters. Hexadecimal characters are A–F, a–f, and 0–9.

**Note:** If you do not know this information, then see the documentation that came with the wireless network, or contact the person who set up your wireless network.

## DISCONNECT FROM VPN SESSION

When you are connected to another network through a VPN connection, you will not be able to access the printer over your wireless network. End your VPN session and try printing again.

## CHECK YOUR ADVANCED SECURITY SETTINGS

- If you are using MAC address filtering to limit access to your wireless network, then you must add the printer MAC address to the list of addresses allowed to connect to the wireless access point.
- If you set the wireless access point to issue a limited number of IP addresses, then you must change this so that the printer can be added.

**Note:** If you do not know how to make these changes, then see the documentation that came with the wireless network, or contact the person who set up your wireless network.

## The Continue button is unavailable

Try the following solutions in the order they appear until the Continue button becomes active and can be clicked:

### CHECK IF THE **USB** CABLE IS SECURELY PLUGGED INTO THE **USB** PORTS ON BOTH THE COMPUTER AND THE PRINTER

USB ports are marked with the  symbol.

### MAKE SURE THAT THE PRINTER IS PLUGGED IN AND TURNED ON

Check to see if the  button is lit. If you have just turned on the printer, then you might need to disconnect the USB cable and reconnect it.

### MAKE SURE THAT THE **USB** PORT ON THE COMPUTER IS WORKING

Test the USB port by connecting other devices to it. If you can successfully use other devices from the port, then the port is working.

If the USB port on the computer is not working, then try using the other USB ports on the computer.

### MAKE SURE THAT THE **USB** CABLE IS WORKING

Try using a different USB cable. If you are using a cable longer than 10 feet, then try using a shorter cable.

### MAKE SURE THAT YOU ARE USING THE CORRECT **CD** FOR YOUR PRINTER MODEL

Compare the printer model on the CD to the printer model on the printer. The numbers should either match exactly or be within the same series.

If you have any doubts, look for an updated version of the printer software on our Web site. For more information, see "Installing the printer software" in the *User's Guide*. You can access the *User's Guide* from the link at the bottom of the installation screen.

### RECONNECT THE POWER SUPPLY

- 1 Turn off the printer.
- 2 Unplug the power cord from the power outlet.
- 3 Remove the power supply from the back of the printer and then plug it back in.
- 4 Plug the power cord back into the power outlet.
- 5 Turn on the printer, and then resume the installation on your computer.

### TRY RUNNING THE INSTALLER AGAIN

- 1 Close the installer.
- 2 Remove the CD, and then restart the computer.
- 3 Insert the CD and then run the installer again.

### Notes:

- When you get to the **Software Already Installed** screen, make sure you select **Install a printer**.
- If you have already set up your printer, select **Additional Computer** when you get to the **Setting up a new printer?** screen to skip the hardware setup wizard.

## CHECK THAT YOUR COMPUTER IS ABLE TO ACKNOWLEDGE USB ACTIVITY ON THE USB PORT

Open the Device Manager to check if it has activity whenever a USB device is connected to a USB port:

- 1 Click , or click **Start** and then click **Run**.
- 2 In the Start Search or Run box, type `devmgmt.msc`.
- 3 Press **Enter**, or click **OK**.  
The Device Manager opens.
- 4 Watch the Device Manager window while connecting a USB cable or another device to the USB port. The window refreshes when Device Manager recognizes the USB connection.
  - If there is activity on Device Manager but none of the previous solutions worked, call Customer Support.
  - If there is no activity on Device Manager, there may be a problem with your computer and its USB support. The computer must recognize the USB connection in order for installation to work.

## Cannot print and there is a firewall on the computer

Third-party (non-Microsoft) firewalls can interfere with wireless printing. If the printer and computer are configured correctly, and the wireless network is working, but the printer will not print wirelessly, then a firewall could be the problem. If there is a firewall (other than the Windows firewall) on the computer, try one or more of the following:

- Update the firewall using the most recent update available from the manufacturer. Refer to the documentation that came with your firewall for instructions on how to do this.
- If programs request firewall access when you install the printer or try to print, make sure you allow those programs to run.
- Temporarily disable the firewall and install the wireless printer on the computer. Re-enable the firewall when you have completed the wireless installation.

## Wi-Fi indicator light is not lit

### CHECK POWER

If the Wi-Fi indicator light is off, make sure the  light is on. If the  light is not on, check the following:

- Make sure the printer is plugged in and turned on.
- Make sure the printer is plugged into a working outlet.
- If the printer is plugged into a power strip, make sure it is turned on and working.

## Wi-Fi indicator light is green but the printer does not print (Windows only)

If you have completed the configuration for wireless printing and all of the settings appear to be correct, but the printer does not print, then try one or more of the following:

### ALLOW THE WIRELESS INSTALLATION TO COMPLETE

Do not attempt to print, remove the installation CD, or detach the installation cable until you see the Wireless Setup Successful screen.

### ENABLE THE PRINTER

Confirm that the printer is enabled:

- 1 Click , or click **Start** and then click **Run**.
- 2 In the Start Search or Run box, type `control printers`.
- 3 Press **Enter**, or click **OK**.  
The printer folder opens.
- 4 Right-click the new printer; from the menu, select **Use Printer Online**.
- 5 Close the Printers or Printers and Faxes window and try printing again.

### SELECT THE WIRELESS PRINTER

You may need to select the wireless printer from your computer to use the printer wirelessly.

- 1 Click , or click **Start** and then click **Run**.
- 2 In the Start Search or Run box, type `control printers`.
- 3 Press **Enter**, or click **OK**.  
The printer folder opens.
- 4 Right-click the printer in the folder with the matching name and model number followed by "(Network)."
- 5 Select **Use Printer Online** from the menu.
- 6 Close the Printers or Printers and Faxes window and try printing again.

### SELECT THE WIRELESS PORT

If you have previously set up your printer as a locally attached printer, then you may need to select the wireless printer to use the printer wirelessly.

- 1 Click , or click **Start** and then click **Run**.
- 2 In the Start Search or Run box, type `control printers`.
- 3 Press **Enter**, or click **OK**.  
The printer folder opens.
- 4 Right-click the printer, and then select **Properties** from the menu.

- 5 Click the **Ports** tab.
- 6 Locate the selected port. The selected port has a check beside it in the Port column.
- 7 If the Description column of the selected port indicates that it is a USB port, scroll through the list and select the port with Printer Port in the Description column. Check the printer model in the Printer column to make sure you select the right printer port.
- 8 Click **OK**, and then try to print again.

## Wi-Fi indicator light is still orange

When the Wi-Fi indicator light is orange, it may indicate that the printer is:

- Not configured in infrastructure mode
- Waiting to make an ad hoc connection to another wireless device

The printer may be unable to join the network because of interference, its distance from the wireless access point (wireless router), or until its settings are changed.

These are possible solutions. Try one or more of the following:

### CHECK NETWORK NAME

Make sure your network does not have the same name as another network near you. For example, if you and your neighbor both use a manufacturer's default network name, your printer could be connecting to your neighbor's network.

If you are not using a unique network name, consult the documentation for your wireless access point (wireless router) to learn how to set a network name.

If you set a new network name, you must reset the printer and computer SSID to the same network name.

### CHECK SECURITY KEYS

#### If you are using WEP security

A valid WEP key is:

- Exactly 10 or 26 hexadecimal characters. Hexadecimal characters are A–F, a–f, and 0–9.  
*or*
- Exactly 5 or 13 ASCII characters. ASCII characters are letters, numbers, and symbols found on a keyboard.

#### If you are using WPA security

A valid WPA passphrase is:

- From 8 to 63 ASCII characters. ASCII characters in a WPA passphrase are case-sensitive.  
*or*
- Exactly 64 hexadecimal characters. Hexadecimal characters are A–F, a–f, and 0–9.

If your wireless network is not using security, then you will not have a security key. Using a wireless network with no security is not recommended because it can allow intruders to use your network resources without your consent.

## MOVE YOUR PRINTER

Move the printer closer to the wireless access point (wireless router). Although the possible distance between devices in 802.11b or 802.11g networks is 300 feet, the maximum range for optimal performance is generally 100-150 feet.

You can find the strength of the network signal on the printer network setup page.

## CHECK MAC ADDRESS

If your network uses MAC address filtering, make sure that you include the MAC address of the printer in the MAC address filter list. This will allow the printer to operate on the network.

## Wi-Fi indicator light is blinking orange during installation

When the Wi-Fi indicator light is blinking orange, it indicates that the printer has been set up for wireless networking but cannot connect to the network for which it has been configured. The printer may be unable to join the network because of interference, its distance from the wireless access point (wireless router), or until its settings are changed.

These are possible solutions. Try one or more of the following:

### MAKE SURE THE ACCESS POINT IS ON

Check the access point and, if necessary, turn it on.

### MOVE YOUR ACCESS POINT TO MINIMIZE INTERFERENCE

There may be temporary interference from other devices such as microwave ovens or other appliances, cordless phones, baby monitors, and security system cameras. Make sure your access point is not positioned too closely to these devices.

### MOVE THE COMPUTER AND/OR PRINTER CLOSER TO THE WIRELESS ACCESS POINT (WIRELESS ROUTER)

Move the computer and/or printer closer to the access point. Although the possible distance between devices in 802.11b or 802.11g networks is 300 feet, the maximum range for optimal performance is generally 100–150 feet.

You can find the signal strength of the network on the network setup page.

## CHECK YOUR WEP KEY OR WPA PASSPHRASE

A WEP key or WPA passphrase is like a password. All devices on a WEP-secured wireless network must share the same WEP key, and all devices on a WPA-secured wireless network must share the same WPA passphrase.

**Note:** Make sure you copy it exactly, including any capital letters, and store it in a safe place for future reference.

### If you are using WEP security

A valid WEP key is:

- Exactly 10 or 26 hexadecimal characters. Hexadecimal characters are A–F, a–f, and 0–9.
- or*
- Exactly 5 or 13 ASCII characters. ASCII characters are letters, numbers, and symbols found on a keyboard.

## If you are using WPA security

A valid WPA passphrase is:



- From 8 to 63 ASCII characters. ASCII characters in a WPA passphrase are case-sensitive.  
*or*
- Exactly 64 hexadecimal characters. Hexadecimal characters are A–F, a–f, and 0–9.

If your wireless network is not using security, then you will not have a security key. Using a wireless network with no security is not recommended because it can allow intruders to use your network resources without your consent.

## CHECK MAC ADDRESS

If your network uses MAC address filtering, make sure that you include the MAC address of the printer in the MAC address filter list. This will allow the printer to operate on the network. For more information, see “How do I find the MAC address?” on page 96.

## PING THE ACCESS POINT TO MAKE SURE THE NETWORK IS WORKING

- 1 If you do not already know it, find the IP address of the access point:
  - a Click , or click **Start** and then click **Run**.
  - b In the Start Search or Run box, type `cmd`.
  - c Press **Enter**, or click **OK**.  
The Command Prompt window opens.
  - d Type `ipconfig`, and then press **Enter**.
    - The “Default Gateway” entry is typically the wireless access point.
    - The IP address appears as four sets of numbers separated by periods, such as 192.168.2.134.
- 2 Ping the access point:
  - a Click , or click **Start** and then click **Run**.
  - b In the Start Search or Run box, type `cmd`.
  - c Press **Enter**, or click **OK**.  
The Command Prompt window opens.
  - d Type `ping` followed by a space and the IP address of the wireless access point. For example:  
`ping 192.168.1.100`
  - e Press **Enter**.
- 3 Check to see whether the access point responds:
  - If the access point responds, you will see several lines appear that start with “Reply from.”  
It is possible that the printer did not connect to the wireless network. Turn off and then restart the printer to try to connect again.
  - If the access point does not respond, it will take several seconds and then you will see “Request timed out.”

Try the following:

  - a Click , or click **Start** and then click **Run**.
  - b In the Start Search or Run box, type `ncpa.cpl`, and then press **Enter**.
  - c Press **Enter** or click **OK**.



- d Select the appropriate connection from the ones shown.
- e Right-click the connection, and then click **Repair**.

## MAKE SURE YOUR COMPUTER CAN COMMUNICATE WITH THE PRINTER

- 1 Obtain the printer IP address by printing a network setup page.
- 2 Click , or click **Start** and then click **Run**.
- 3 In the Start Search or Run box, type `cmd`.
- 4 Press **Enter**, or click **OK**.  
The Command Prompt window opens.
- 5 Type `ping` followed by a space and the IP address of the printer. For example:  
`ping 192.168.1.100`
- 6 Press **Enter**.
- 7 If the printer responds, you will see several lines that display the number of bytes received from the printer. This ensures that your computer is communicating with your printer.  
If the printer does not respond, then "Request timed out" displays.
  - Your computer might not be connected to the network.
  - You may need to change the settings of your printer. Run the Wireless Setup Utility again.

## CONFIGURE THE PRINTER FOR WIRELESS ACCESS AGAIN

If your wireless settings have changed, you must run the printer wireless setup again. Some reasons your settings may have changed include your having manually changed your WEP or WPA keys, channel, or other network settings; or the access point having been reset to factory defaults.

Running the wireless setup again can also resolve issues due to misconfigurations that occurred when configuring the printer for wireless access.

### Notes:

- If you change network settings, change them on all the network devices before changing them for the access point.
  - If you have already changed the wireless network settings on your access point, then you must change the settings on all the other network devices before you can see them on the network.
- 1 Click , or **Start**.
  - 2 Click **All Programs** or **Programs**, and then select the printer program folder from the list.
  - 3 Select **Printer Home**.
  - 4 Click the **Settings** tab.
  - 5 Click the **Wireless setup utility** link.  
**Note:** You may be prompted to connect the printer to the computer again using the installation cable as part of the setup process.
  - 6 Follow the instructions on the computer screen.

## Wireless print server not installed

You may see a message during installation indicating that the printer does not have a wireless print server installed. If you are sure the printer is capable of wireless printing, try the following:

### CHECK POWER

Make sure the  light is on.

## “Communication not available” message displays when printing wirelessly

These are possible solutions. Try one or more of the following:

### MAKE SURE YOUR COMPUTER AND PRINTER HAVE VALID IP ADDRESSES FOR THE NETWORK

If you are using a laptop and have power saving settings enabled, you may see the **Communication not available** message on your computer screen when you attempt to print wirelessly. This can occur if the laptop hard drive has powered down.

If you see this message, wait a few seconds and then try to print again. The laptop and printer require a few seconds to power up again and reattach to the wireless network.

If you see this message again after you have waited long enough for the printer and the laptop to attach to the network, there may be a problem with your wireless network.

Make sure that the laptop and printer have both received IP addresses:

- 1 Click , or click **Start** and then click **Run**.
- 2 In the Start Search or Run box, type `cmd`.
- 3 Press **Enter**, or click **OK**.

The Command Prompt window opens.

- 4 Type `ipconfig`, and then press **Enter**.

The IP address appears as four sets of numbers separated by periods, such as 192.168.0.100.

### How to locate a printer IP address

- You can locate the printer IP address by viewing the printer network setup page.

If the printer and/or the laptop does not have an IP address, or if either has an address of 169.254.x.y (where x and y are any two numbers between 0 and 255):

- 1 Turn off the device that does not have a valid IP address (the laptop, the printer, or both).
- 2 Turn on the device(s).
- 3 Check the IP addresses again.

If the laptop and/or printer still does not receive a valid IP address, there is a problem with your wireless network. Try the following:

- Make sure your wireless access point (wireless router) is turned on and is working.
- Remove any objects that could be blocking the signal.

- Temporarily turn off any unnecessary wireless devices on your network and pause any network-intensive activities, like large file transfers or network games. If the network is too busy, it is possible that the printer is not receiving the IP address within the allowed time.
- Make sure your DHCP server, which may also be your wireless router, is working and is configured to assign IP addresses. If you are not sure how to do this, refer to the manual that came with your wireless router for more information.

If the printer and computer have valid IP addresses and the network is operation correctly, continue troubleshooting.

## MAKE SURE THE WIRELESS PORT IS SELECTED

- 1 Click , or click **Start** and then click **Run**.
- 2 In the Start Search or Run box, type `control printers`.
- 3 Press **Enter**, or click **OK**.  
The printer folder opens.
- 4 Right-click the printer, and then select **Properties** from the menu.
- 5 Click the **Ports** tab.
- 6 Locate the selected port. The selected port has a check beside it in the Port column.
- 7 If the Description column of the selected port indicates that it is a USB port, scroll through the list and select the port with Printer Port in the Description column. Check the printer model in the Printer column to make sure you select the right printer port.
- 8 Click **OK**, and then try to print again.

## MAKE SURE BIDIRECTIONAL COMMUNICATION IS ENABLED

- 1 Click , or click **Start** and then click **Run**.
- 2 In the Start Search or Run box, type `control printers`.
- 3 Press **Enter**, or click **OK**.  
The printer folder opens.
- 4 Right-click the printer, and then select **Properties** from the menu.
- 5 Click the **Ports** tab.
- 6 Click the box next to **Enable bidirectional support** if it is not already checked.
- 7 Click **Apply**.
- 8 Click **OK**, and then try to print again.

## Communication with printer lost when connected to Virtual Private Network (VPN)

You will lose your connection to a wireless printer on your local network when connected to most *Virtual Private Networks* (VPNs). Most VPNs allow users to communicate with only the VPN and no other network at the same time. If you would like to have the ability to connect to your local network and to a VPN at the same time, the system support person for the VPN must enable split tunneling. Be aware that some organizations will not allow split tunneling due to security or technical concerns.

## Resolving intermittent wireless communications issues

You may notice that your printer works for a short time and then stops working, although apparently nothing has changed on your wireless network.

Many different issues can interrupt network communications, and sometimes more than one problem exists at the same time. These are possible solutions. Try one or more of the following:

### DISCONNECT FROM ALL VPNs WHEN ATTEMPTING TO USE THE WIRELESS NETWORK

Most Virtual Private Networks (VPNs) allow computers to communicate with only the VPN and no other network at the same time. Disconnect from the VPN before installing the driver on the computer or before running the wireless setup on the computer.

To check if the computer is currently connected to a VPN, open your VPN Client software and check your VPN connections. If you do not have a VPN Client software installed, check the connections manually using the Windows VPN Client.

If you would like to have the ability to connect to your local network and to a VPN at the same time, the system support person for the VPN must enable split tunneling. Be aware that some organizations will not allow split tunneling due to security or technical concerns.

### TURN OFF THE WIRELESS ACCESS POINT (WIRELESS ROUTER) AND TURN IT BACK ON AGAIN

### ELIMINATE NETWORK CONGESTION

If a wireless network is too busy, the computer and printer may have difficulty communicating with each other. Some causes of wireless network congestion can include:

- Transferring large files across the network
- Networked games
- Peer-to-peer file swapping applications
- Streaming video
- Too many computers on the wireless network at once

### ELIMINATE SOURCES OF INTERFERENCE

Common household items can potentially disrupt wireless network communications. Cordless phones (but not cellular phones), microwave ovens, baby monitors, almost any kitchen appliance, wireless surveillance equipment, nearby wireless networks, and any appliance containing a motor can disrupt wireless network communications.

Try turning on any potential sources of interference and see if it causes the problem. If it does, separate your wireless network from the device.

## CHANGE THE CHANNEL THE WIRELESS ROUTER USES

You can sometimes eliminate interference from unknown sources by changing the channel your wireless router uses to broadcast. There are three distinct channels on a router. Check the documentation that came with your router to determine which three apply. Other channels are offered as options, but these overlap. If the router is configured to use the default settings, change the channel setting to use a different distinct channel. Refer to the manual that came with your wireless router if you are not sure how to change the channel.

## CONFIGURE THE WIRELESS ROUTER WITH A UNIQUE SSID

Many wireless networks use the SSID that the router was originally configured by the manufacturer to use. Using the default SSID can cause problems when more than one network is operating in the same area with the same SSID. The printer or computer may attempt to attach to the wrong network, although it will appear to be trying to connect to the correct network.

To avoid this type of interference, change the SSID on your wireless router from the default. Refer to the manual that came with your router if you are not sure how to change the SSID.

**Note:** You must change the SSID on all of the other devices that access your wireless network if you change the SSID on the router.

## ASSIGN STATIC IP ADDRESSES TO ALL DEVICES IN THE NETWORK

Most wireless networks use a DHCP server (dynamic host configuration protocol) built in to the wireless router to assign IP addresses to clients on the wireless network. DHCP addresses are assigned when they are needed, as when a new device is added to the wireless network or when it is powered on. Wireless devices must send a request to the router, and receive an IP address in response so they can function on the network. Because the router performs many other tasks besides assigning addresses, it sometimes does not respond quickly enough with an address. The requesting device sometimes gives up before it receives an address.

Try assigning static IP addresses to the devices in your network to resolve this issue. Static IP addresses cut down on the work your wireless router has to do. Refer to the manual that came with your router and your operating system documentation if you are not sure how to assign static IP addresses.

To assign a static IP address to the printer, do the following:

- 1 Complete the wireless setup, allowing the printer to receive a DHCP address from a DHCP server on the network.
- 2 Print a network setup page to see what IP address is currently assigned to the printer.
- 3 Open a Web browser and then type the printer IP address in the address field. Press **Enter**.  
The printer Web page loads.
- 4 Click the **Configuration** link.
- 5 Click the **TCP/IP** link.
- 6 Click the **Set Static IP Address** link.
- 7 Type the IP address you want to assign to the printer in the **IP Address** field.
- 8 Click the **Submit** button.

The Submitting Selection message appears.

Confirm that the IP address is updated by typing the static IP address in the browser address field and checking to see if the printer Web page reloads.

## **CHECK FOR KNOWN ISSUES WITH THE WIRELESS ROUTER**

Some wireless routers have documented defects that were identified and resolved by the manufacturers. Visit the company Web site of the router manufacturer. Check for firmware updates and other advice from the manufacturer. Check the manual that came with your wireless router if you are not sure how to reach the manufacturer Web site.

## **CHECK FOR WIRELESS ADAPTER UPDATES**

If you are having trouble printing from one particular computer, check the Web site of the manufacturer of the network adapter card in that computer. It is possible that there is an updated driver available that could resolve the issue.

## **CHANGE ALL NETWORK DEVICES TO THE SAME TYPE**

While it is possible to successfully mix 802.11b, 802.11g, and 802.11n devices on the same wireless network, the faster devices will sometimes prevent the slower devices from communicating. Wireless devices are designed to wait for a gap in wireless network communications before attempting to send information. If newer, faster devices are constantly using the wireless network, then older, slower devices will not have a chance to send data.

Try only turning on the network devices of the same type and see if network communications improve. If this solves the problem, you may want to upgrade your older devices with newer network adapters.

## **PURCHASE A NEW ROUTER**

If your router is several years old, it may not be fully compatible with the newer wireless devices on your network. Consider purchasing a newer router that is fully compliant with the 802.11 IEEE specifications.

# Index

## A

- ad hoc
  - SSID 84
  - WEP 84
- ad hoc network 92
- ad hoc wireless network
  - adding a printer 86
  - creating using Windows 84
- additional computers
  - installing wireless printer 82
- Address Book
  - setting up 70
- Address Book, fax
  - setting 68
- adjusting dialing and ringer volume 76
- adjusting speaker volume 76
- AliceBox 83
- aligning the printhead 98
- answering machine
  - best settings for fax 76
  - setting up 57
- appliances
  - wireless network 94
- application list
  - downloading 56
  - updating 56
- assigning IP address 97
- Auto Answer
  - when to turn on 74
- Automatic Document Feeder (ADF) 11
  - clearing a paper jam in 107
  - loading documents 29
  - output tray 11
  - paper capacity 29
  - paper guide 11
  - tray 11
- automatic fax conversion
  - setting 68

## B

- banner paper 27
- bidirectional communication
  - enabling 130
- black and white scanning 55
- blocking faxes 79

- Bluetooth
  - printing 43
  - setting the security level 43
  - setting up a connection 41
- broadcast fax, sending
  - immediately 71
- buttons, printer control panel
  - Address Book 17
  - Back 17
  - Cancel 18
  - Color/Black 18
  - Copy 16
  - Dialtone 18
  - Display 17
  - Fax 16
  - Keypad 18
  - Photo 16
  - Power 16
  - Scan 16
  - Select 17
  - Settings 17
  - Start 18

## C

- cable
  - installation 91, 92
  - USB 92
- Caller ID 67
- Caller ID pattern, fax
  - setting 68
- camera
  - connecting 39
- canceling
  - copy job 51
  - print job 46
  - scan job 56
- cannot delete documents from print queue 106
- cannot print from a flash drive 119
- cannot print over wireless network 121
- cannot print through USB 106
- cannot receive faxes 115
- cannot run fax software 116
- cannot scan to computer over a network 111
- cannot send faxes 113
- changing Power Saver timeout 21
- changing printing mode 45
- changing temporary settings into default 20
- changing wireless settings after installation (Windows) 84
- checking an unresponsive printer 101
- checking ink levels 98
- checking the dial tone 75
- checklist
  - before you troubleshoot 101
  - fax troubleshooting 112
  - memory card
    - troubleshooting 118
- choosing a splitter, faxing 74
- cleaning exterior of the printer 99
- cleaning printhead nozzles 99
- Club Internet 83
- collating copies 49
- Communication not available message 130
- computer slows down when printing 110
- configuring
  - fax settings 68
  - IP address 83
- confirmation page, fax 78
- connection
  - configurations 95
- conserving energy, ink, and paper 8
- conserving paper
  - using Eco-Mode 22
- contact list
  - setting up 70
- continue button greyed out 123
- continue button not working 123
- continue button unavailable 123
- copier or scanner does not respond 110
- copies
  - making 47
- copy and scan troubleshooting
  - cannot scan to computer over a network 111
  - copier or scanner does not respond 110

- partial document or photo
  - scans 111
- poor scanned image quality 110
- scan not successful 111
- scanning takes too long or freezes the computer 111
- copy job
  - canceling 51
- copy quality, adjusting 48
- copy troubleshooting
  - scanner unit does not close 110
- copying 47
  - adjusting quality 48
  - collating copies 49
  - enlarging an image 48
  - making a copy lighter or darker 49
  - multiple page images on one sheet 50
  - on both sides of the paper 50
  - Pages per Sheet 50
  - photos 47
  - reducing an image 48
  - repeating an image 50
  - tips 47
- custom-size paper
  - printing on 34

## D

- default printer, setting 44
- defaults
  - resetting factory defaults 21
- dial method, fax
  - setting 68
- dial tone
  - checking 75
- dial tone volume
  - adjusting 76
- dialing prefix 74
- Digital Subscriber Line (DSL)
  - fax setup 60
- digital telephone service
  - fax setup 62
- disabling settings timeout 20
- distinctive ring 75
- documents
  - faxing using the computer 72
  - faxing using the control panel 71
  - loading into the Automatic Document Feeder (ADF) 29
  - loading on scanner glass 29
  - printing 31

- scanning for editing 54
- scanning using the printer control panel 52
- DSL filter 60
- duplex
  - copying, manual 50
  - printing, manual 34
- duplex cover 11

## E

- Eco-Mode
  - using 22
- energy
  - conserving 8
- enlarging an image 48
- entering
  - fax user information 67
- envelopes 27
  - loading 33
  - printing 33
- error correction, fax
  - setting 68
- error using memory card 118
- Ethernet 95
- exterior of the printer
  - cleaning 99
- e-mailing
  - scanned documents 54

## F

- factory default settings
  - resetting internal wireless print server 120
  - resetting to 21
- failed faxes
  - retrieving 79
- fax
  - confirmation page 78
  - printer memory 79
  - transmission report 78
- fax activity report 78
- fax blocking
  - setting 68
- fax error messages
  - Digital Line Detected 117
  - Failed To Connect 117
  - Fax Mode Unsupported 116
  - Fax Modem Error 117
  - No Answer 118
  - No Caller ID 118
  - Phone Line Busy 117

- Phone Line Error 117
- Phone Line is connected to the incorrect jack on the back of the machine 117
- Phone Line Not Connected 117
- Remote Fax Error 116
- Unrecoverable Fax Error 117
- Unsupported Compression 117
- Unsupported Resolution 117
- fax footer
  - setting 68
- fax forwarding 78
- fax header
  - setting 68
- fax header and footer
  - setting 67
- fax number 74
- fax printing
  - setting 68
- fax quality
  - setting 77
- fax resolution
  - setting 77
- fax sending speed
  - setting 68
- fax settings
  - configuring 68
  - for answering machine 76
  - for voice mail 76
- fax setup
  - country-specific 63
  - digital telephone service 62
  - DSL connection 60
  - standard telephone line connection 57
  - VoIP 61
- Fax Setup Utility 68
- Fax Setup Wizard 68
- fax troubleshooting
  - cannot receive faxes 115
  - cannot run fax software 116
  - cannot send faxes 113
  - error messages, printer control panel 116
- fax troubleshooting checklist 112
- faxing
  - Address Book 70
  - blocking 79
  - calling card, using 77
  - dial prefix 74
  - distinctive ring 75
  - pick up on 75



- receiving automatically 72
  - receiving manually 73
  - rings 75
  - scheduling 77
  - sending a broadcast fax
    - immediately 71
  - sending using the control panel 71
  - setup 73
  - tips, receiving 72
  - tips, sending 71
  - using the computer 72
  - using the control panel 71
  - faxing tips
    - receiving faxes automatically 72
    - receiving faxes manually 73
  - file types
    - supported 37
  - finding
    - information 9
    - MAC address 96
    - publications 9
    - Web site 9
  - firewall on computer 124
  - flash drive
    - inserting 36
    - printing documents from 32
    - printing photos using the proof sheet 40
    - scanning to 53
  - forwarding faxes 78
  - France
    - special wireless setup instructions 83
  - FreeBox 83
- G**
- greeting cards 28
  - Group Dial
    - setting up 70
- H**
- heavyweight matte paper 27
- I**
- improving scan quality 55
  - incorrect language appears on display 102
  - index cards 28
  - information
    - finding 9
  - information needed for setting up
    - printer on wireless network 81
  - infrastructure network 92
  - ink
    - conserving 8
  - ink cartridges
    - ordering 14
    - replacing 13
  - ink levels
    - checking 98
  - inserting a memory card or flash drive 36
  - installation
    - cable 91, 92
  - installing
    - network printer 97
  - installing printer
    - on wireless network (Windows) 82
  - installing printer software 25
  - installing wireless printer
    - additional computers 82
  - interference
    - wireless network 94
  - internal wireless print server
    - resetting to factory default settings 120
  - IP address 96, 97
    - configuring 83
  - IP address, assigning 97
  - iron-on transfers 28
- J**
- jams and misfeeds troubleshooting
    - paper jam in the ADF 107
    - paper jam in the paper support 107
    - paper jam in the printer 106
    - paper or specialty media 108
  - junk faxes
    - blocking 79
- K**
- key index 97
- L**
- labels 27
    - printing 34
  - language
    - changing 102
  - line filter 60
- LiveBox** 83
- loading
    - documents into the Automatic Document Feeder (ADF) 29
    - documents on scanner glass 29
    - envelopes 33
  - loading paper 26
  - locating
    - SSID 89
    - WEP key 89
    - WPA passphrase 89
- M**
- MAC address 95
    - finding 96
  - MAC address filtering 95
  - memory card
    - inserting 36
    - printing documents from 32
    - printing photos using the proof sheet 40
    - scanning to 53
    - supported types 37
  - memory card cannot be inserted 118
  - memory card slots 11
  - memory card troubleshooting
    - cannot print from a flash drive 119
    - checklist 118
    - nothing happens when memory card is inserted 118
  - menus
    - diagram of 18
  - menus list 18
  - minimum system requirements 23
  - multiple WEP keys 97
- N**
- N9UF Box 83
  - network connection
    - with USB 95
  - network overview 89
  - network printer
    - installing 97
  - network security 90
  - network setup page
    - printing 81
  - networking
    - finding IP address of computer 97

- finding IP address of printer 97
- IP addresses 97
- no wireless network 84
- nothing happens when memory card is inserted 118

## O

- on-hook faxing 77

## P

- page does not print 104
- Pages per Sheet copies 50

- paper

  - conserving 8

- paper and media

  - banner paper 27

  - envelopes 27

  - heavyweight matte paper 27

  - index cards 28

  - iron-on transfers 28

  - photo cards 28

  - photo/glossy paper 28

  - plain paper 26

  - postcards 28

  - transparencies 28

- paper default settings

  - saving 28

- paper exit tray 11

- paper feed guard 11

- paper guides 11

- paper jam in the ADF 107

- paper jam in the paper support 107

- paper jam in the printer 106

- paper or specialty media

  - misfeeds 108

- paper support 11

- partial document or photo

  - scans 111

- parts

  - Automatic Document Feeder (ADF) 11

  - Automatic Document Feeder (ADF) output tray 11

  - Automatic Document Feeder (ADF) paper guide 11

  - Automatic Document Feeder (ADF) tray 11

  - duplex cover 11

  - memory card slots 11

  - paper exit tray 11

- paper feed guard 11

- paper guides 11

- paper support 11

- PictBridge port 11

- power supply port 12

- printer control panel 11

- printhead 12

- scanner glass 12

- scanner unit 12

- security slot 12

- top cover 12

- USB port 12

- Wi-Fi indicator 11

- password 90

- pausing

  - print job 45

- PDF

  - creating from scan 55

- phone book

  - setting up 70

- phone plug 63

- phone splitter 61

- photo cards 28

- photo/glossy paper 28

- photos

  - copying photos 47

  - making borderless copies 48

  - printing from digital camera using DPOF 41

  - printing using printer control panel 37

  - printing using the proof sheet 40

  - scanning for editing 53

- photos do not print from memory

  - card across wireless network 119

- photos from memory device

  - printing using printer

    - software 38

- PictBridge port 11

- PictBridge-enabled camera

  - connecting 39

- plain paper 26

- poor quality at the edges of page 108

- poor scanned image quality 110

- postcards 28

- Power Saver timeout

  - changing 21

- power supply port 12

- print job

  - canceling 46

  - pausing 45

  - resuming 45

- print media

  - greeting cards 28

  - labels 27

- print speed is slow 109

- print troubleshooting

  - cannot delete documents from print queue 106

  - computer slows down when printing 110

  - poor quality at the edges of page 108

  - slow print speed 109

  - streaks or lines on printed image 109

- printer

  - sharing 87

  - sharing in Windows 87

- printer control panel 11

  - using 16

- printer does not print

  - wireless 124

- printer does not print

  - wirelessly 125

- printer does not respond 105

- printer memory

  - fax 79

- printer menus 18

- printer printing blank pages 105

- printer problems, basic solutions 101

- printer software

  - installing 25

  - uninstalling 25

- printer, setting as default 44

- printhead 12

  - aligning 98

- printhead error 102

- printhead nozzles

  - cleaning 99

- printing

  - collate 31

  - custom-size paper 34

  - documents 31

  - documents from memory card or flash drive 32

  - envelopes 33

  - from a Bluetooth-enabled device 43

  - from a PictBridge-enabled camera 39

  - labels 34

- last page first 32
- multiple pages on one sheet 32
- network setup page 81
- on both sides of the paper 34
- photos from digital camera using DPOF 41
- photos from memory device using printer software 38
- photos using printer control panel 37
- photos using the proof sheet 40
- reverse page order 32
- tips 31
- two-sided 34
- printing a confirmation page 78
- printing a transmission report 78
- printing in draft mode 45
- printing mode
  - changing 45
- proof sheet
  - using 40
- protocol 97
- publications
  - finding 9

## R

- received history report 78
- receiving faxes
  - Auto Answer setting 72, 73
  - automatically 72
  - manually 73
  - tips 72, 73
- recycling 8
  - Dell products 15
- redial attempts, fax
  - setting 68
- redial time, fax
  - setting 68
- reducing an image 48
- registering
  - fax user information 67
  - Transmit Terminal Identification (TTI) 67
- repeating an image 50
- replacing ink cartridges 13
- reports
  - fax history 78
- reports, fax
  - setting 68
- resetting
  - internal wireless print server to factory default settings 120

- resetting to factory defaults 21
- resuming
  - print job 45
- reverse page order 32
- ringer volume
  - adjusting 76
- RJ-11 adapter 63

## S

- safety information 7
- saving paper default settings 28
- scan
  - black and white 55
  - improving quality 55
  - PIN 55
- scan job
  - canceling 56
- scan was not successful 111
- scanner glass 12
  - cleaning 100
- scanner unit 12
- scanner unit does not close 110
- scanning
  - creating a PDF from scan 55
  - documents for editing 54
  - documents for e-mailing 54
  - photos for editing 53
  - tips 52
  - to a computer 52
  - to a flash drive 53
  - to a memory card 53
  - to a network 52
  - using the printer control panel 52
- scanning takes too long or freezes the computer 111
- scheduled fax
  - sending 77
- security
  - wireless network 80
- security information
  - wireless network 90
- security key 90
- selecting the wireless port 130
- sender information
  - registering 67
- sending a scheduled fax 77
- sending faxes, tips 71
- sent history report 78
- Service Center 101
- setting
  - Auto Answer 74

- Caller ID 67
- fax header and footer 67
- fax quality 77
- maximum sending speed 68
- sender information 67
- Transmit Terminal Identification (TTI) 67
- setting up fax
  - country-specific 63
  - digital telephone service 62
  - DSL connection 60
  - standard telephone line connection 57
  - VoIP connection 61
- setting up printer
  - faxing 73
  - on wireless network (Windows) 82
- settings timeout
  - disabling 20
- setup troubleshooting
  - cannot print through USB 106
  - incorrect language appears on display 102
  - page does not print 104
  - printer does not respond 105
  - printer printing blank pages 105
  - printhead error 102
  - software did not install 103
- sharing printer in Windows 87
- software
  - Service Center 101
  - software did not install 103
  - software updates
    - checking 25
    - enabling 25
- speaker volume
  - adjusting 76
- Speed Dial
  - setting up 70
- splitter, choosing 74
- SSID
  - ad hoc 84
  - finding 95
  - locating 89
  - wireless network 89
- streaks or lines on printed image 109
- supported memory cards and file types 37
- supported operating systems 23

switching from USB  
to wireless 87  
switching from wireless  
to USB 87

## T

TCP/IP 97  
technical support 101  
temporary settings  
changing into default 20  
tips for  
copying 47  
printing 31  
receiving faxes 72  
scanning 52  
sending faxes 71  
top cover 12  
transmission report, fax 78  
transparencies 28  
troubleshooting  
checking an unresponsive  
printer 101  
contacting technical support 101  
fax checklist 112  
Service Center 101  
solving basic printer  
problems 101  
wireless network 120  
troubleshooting, copy  
scanner unit does not close 110  
troubleshooting, copy and scan  
cannot scan to computer over a  
network 111  
copier or scanner does not  
respond 110  
partial document or photo  
scans 111  
poor scanned image quality 110  
scan not successful 111  
scanning takes too long or freezes  
the computer 111  
troubleshooting, fax  
cannot receive faxes 115  
cannot run fax software 116  
cannot send faxes 113  
error messages, printer control  
panel 116  
troubleshooting, jams and  
misfeeds  
paper jam in the ADF 107  
paper jam in the paper  
support 107

paper jam in the printer 106  
paper or specialty media 108  
troubleshooting, memory card  
cannot print from a flash  
drive 119  
checklist 118  
nothing happens when memory  
card is inserted 118  
troubleshooting, print  
cannot delete documents from  
print queue 106  
computer slows down when  
printing 110  
poor quality at the edges of  
page 108  
slow print speed 109  
streaks or lines on printed  
image 109  
troubleshooting, setup  
cannot print through USB 106  
incorrect language appears on  
display 102  
page does not print 104  
printer does not respond 105  
printer printing blank pages 105  
printhead error 102  
software did not install 103  
troubleshooting, wireless  
cannot print over wireless  
network 121  
changing wireless settings after  
installation (Windows) 84  
photos do not print from memory  
card across wireless  
network 119  
resolving communication  
problems 132  
Wi-Fi indicator light is blinking  
orange 127  
Wi-Fi indicator light is not lit 124  
Wi-Fi indicator light is still  
orange 126  
TX report, fax 78

## U

UK  
special wireless setup  
instructions 83  
uninstalling printer software 25  
updating printer software 25  
updating the application list 56

USB 87, 95  
cable 92  
USB connection  
with network connection 95  
USB port 12  
user information, fax  
setting 68

## V

Virtual Private Network 132  
voice mail  
setting up 57  
voice mail, fax settings 76  
Voice over Internet Protocol (VoIP)  
fax setup 61  
VoIP adapter 61  
volume, adjusting  
ringer and dial tone 76  
speaker 76  
VPN  
lose connection to printer 132

## W

Web site  
finding 9  
WEP 80  
ad hoc 84  
WEP key  
key index 97  
locating 89  
Windows  
installing printer on wireless  
network 82  
Windows software  
Abbyy Sprint OCR 23  
Fast Pics 23  
Fax Setup Utility 23  
Fax Solutions software 23  
Printer Home 23  
Printing Preferences 23  
Service Center 23  
Toolbar 23  
Wireless Setup Utility 23  
wireless 87, 95  
printer does not print 124  
troubleshooting 125, 132  
wireless network  
adding a printer to existing ad hoc  
network 86  
common home configurations 90

- creating an ad hoc network using
  - Windows 84
- information needed for setting up
  - wireless printing 81
- installing printer on
  - (Windows) 82
- interference 94
- resolving communication
  - problems 132
- security 80
- security information 90
- signal strength 93
- SSID 89
- troubleshooting 120
- types of wireless networks 92
- wireless network compatibility 80
- wireless print server
  - not installed 130
- wireless setup
  - information needed for 81
- wireless signal
  - strength 93
- wireless signal absorption 94
- wireless troubleshooting
  - cannot print over wireless
    - network 121
  - changing wireless settings after
    - installation (Windows) 84
  - photos do not print from memory
    - card across wireless
      - network 119
  - printer and computer on different
    - networks 95
  - printer works intermittently on
    - wireless network 132
  - Wi-Fi indicator light is blinking
    - orange 127
  - Wi-Fi indicator light is not lit 124
  - Wi-Fi indicator light is still
    - orange 126
- Wi-Fi indicator 11
  - description of colors 82
  - light is not lit 124
- Wi-Fi indicator light is blinking
  - orange 127
- Wi-Fi indicator light is green
  - printer does not print 125
- Wi-Fi indicator light is still
  - orange 126
- Wi-Fi Protected Setup 87
  - using 88
- Wi-Fi Protected Setup logo
  - identifying 88
- WPA 80
- WPA passphrase
  - locating 89
- WPA2 80
- WPS 87